

TASSENSTÄNDER

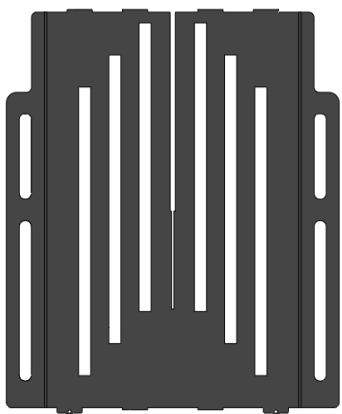

Nr.:1 = 1 Stück

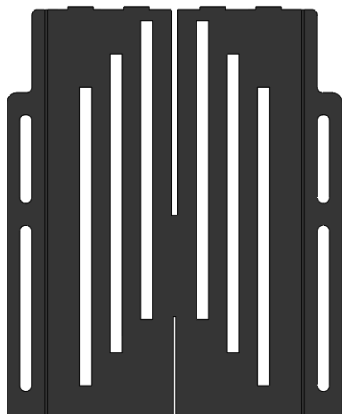

Nr.:2 = 1 Stück

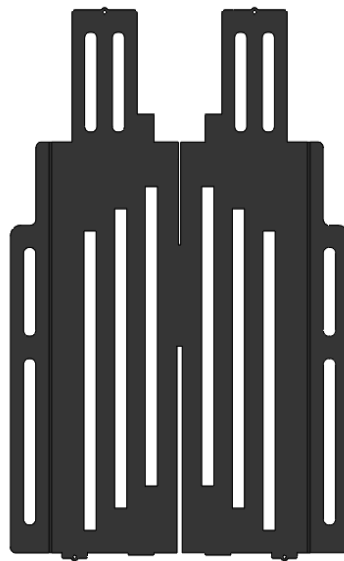

Nr.:4 = 1 Stück

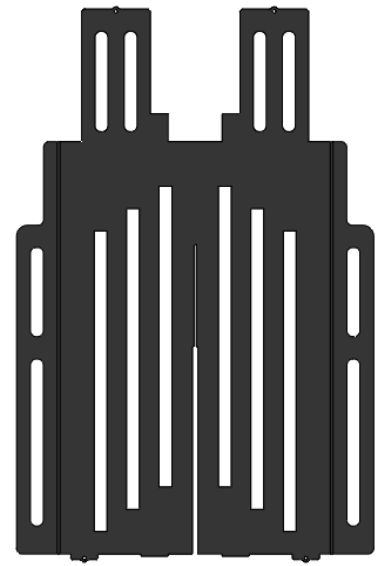

Nr.:5 = 1 Stück

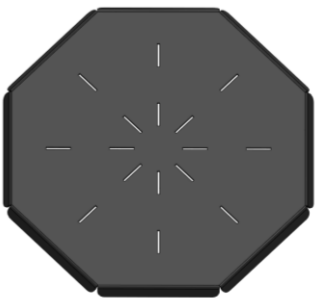

Nr.:3 = 1 Stück

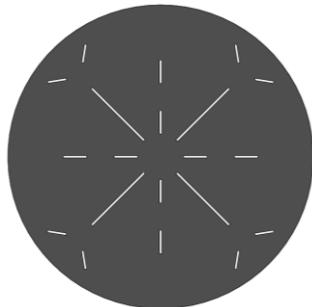

Nr.:6 = 1 Stück



Nr.:7 = 4 Stück

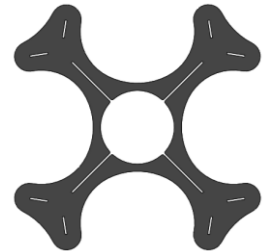

Nr.:8 = 1 Stück



Splint = 12 Stück

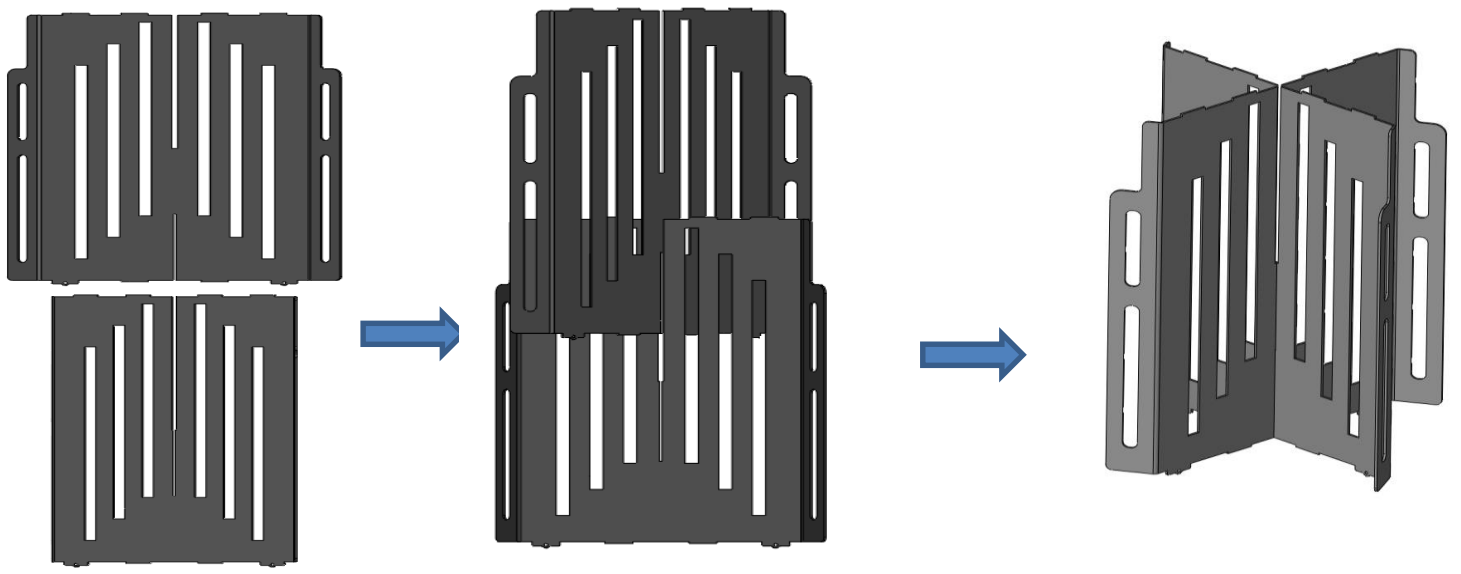

Nr. 1 und Nr. 2 + sollten in ineinander gesetzt werden

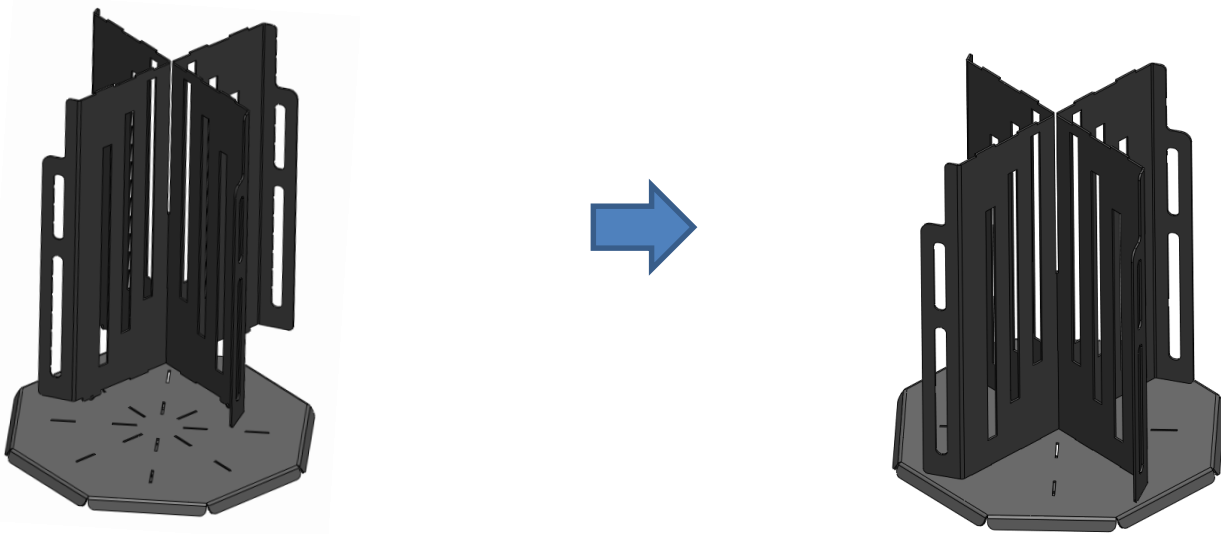

Nr. 1 und Nr. 2 nach der Montage, da das nächste Bild mit Nr. 3 zusammengesetzt wird

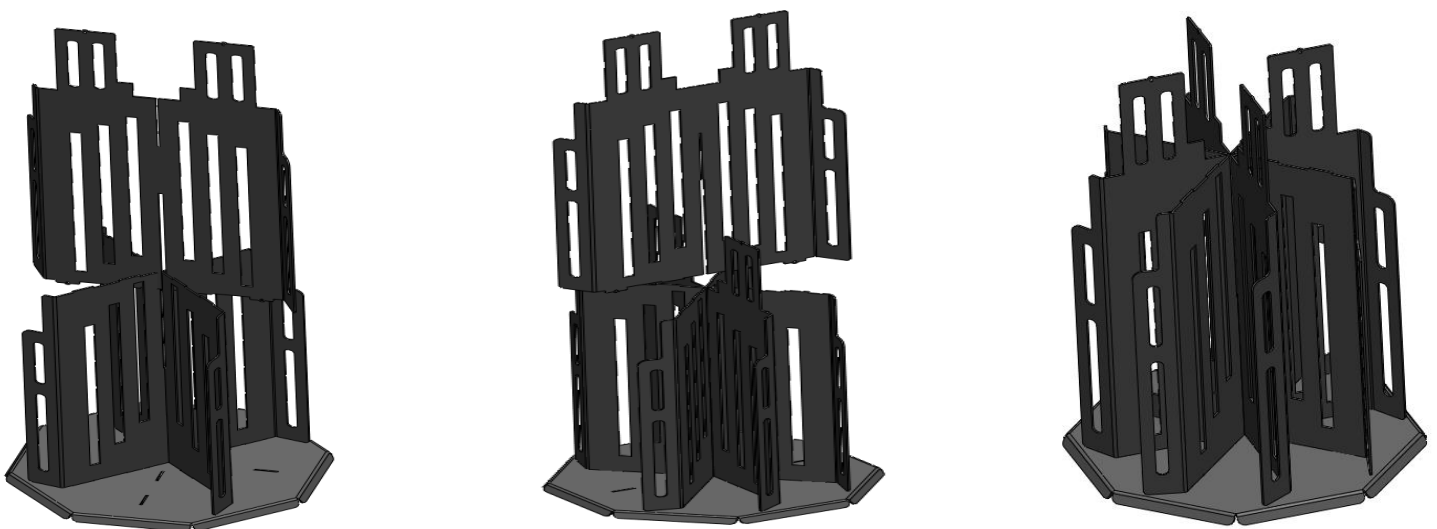

Nach montierten Teilen (Nr. 1, Nr. 2, Nr. 3) müssen jeweils Nr. 4 und Nr. 5 kombiniert werden.

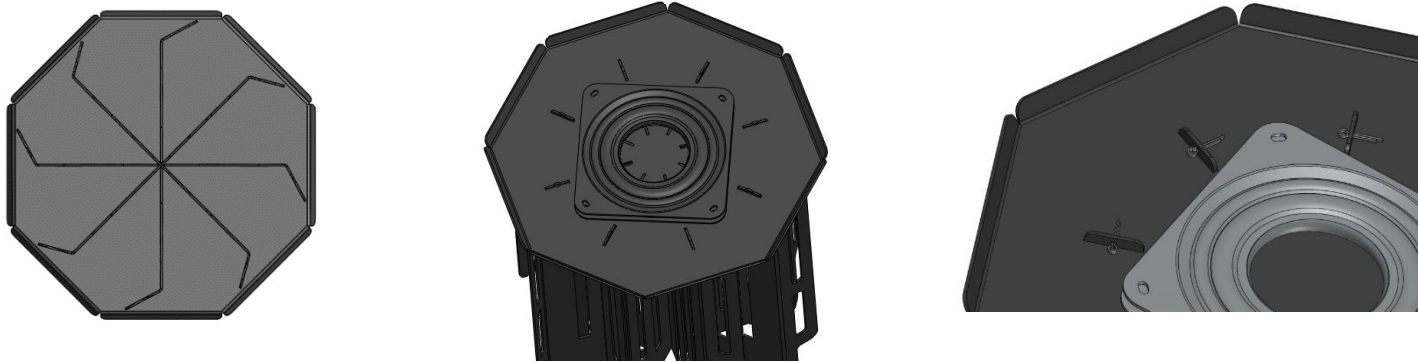

Nach dem Zusammenbau der Teile muss er umgedreht und unter allen Kanten mit dem Splint befestigt werden.

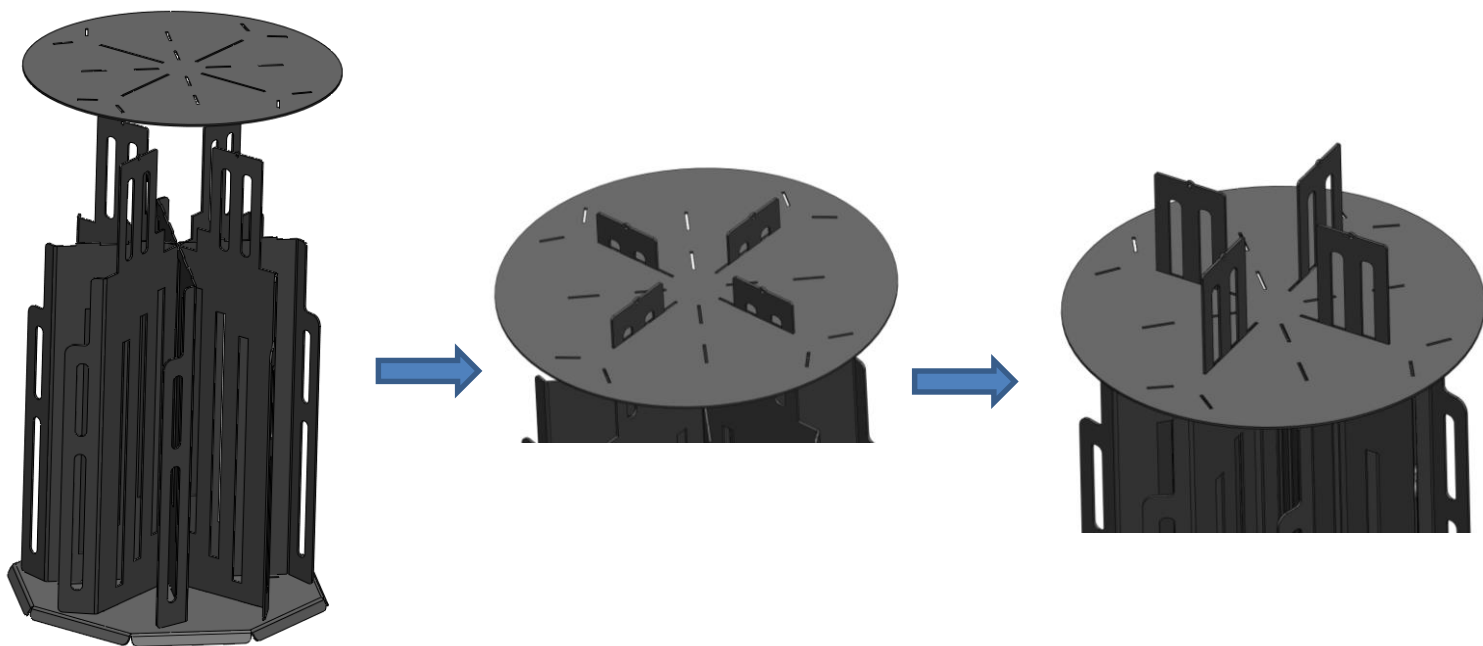

Der nächste Schritt, der mit einem Splint installiert wird, kann mit Nr. 6 kombiniert werden.

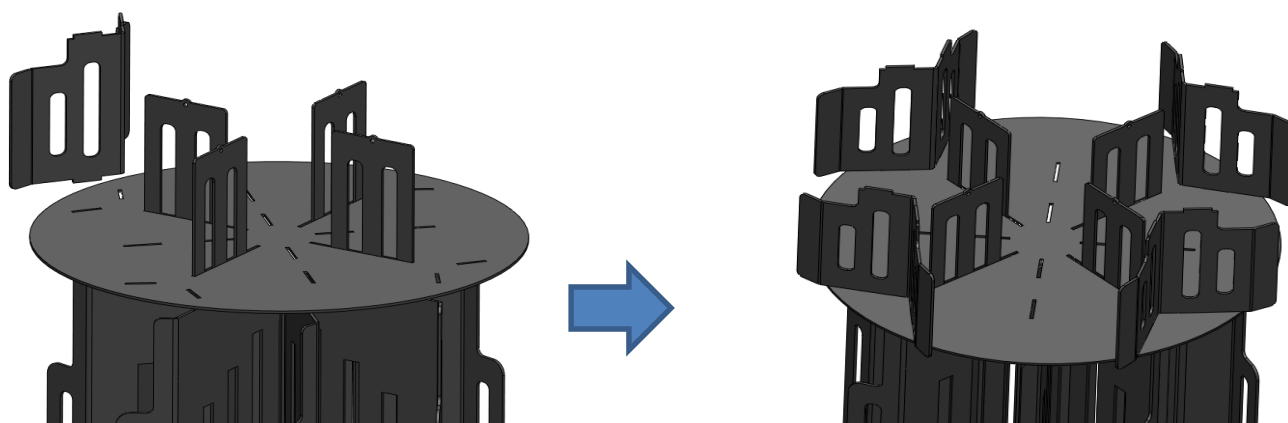

Die Seitenkanten (Nr. 7) sollten so montiert werden, dass die Platten



Der obere Teil der Verriegelungsplatte sollte mit (Nr. 8) verbunden und mit einem Splint befestigt werden.

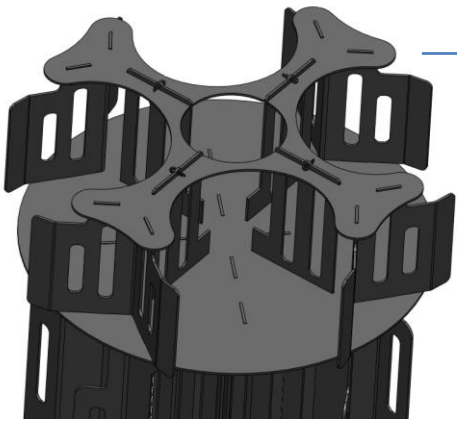

Bitte stellen Sie die
Metallschüssel für den Löffel in
den runden Bereich.

CUP STAND

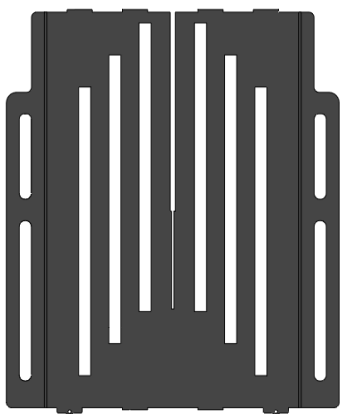

No:1 = 1 piece

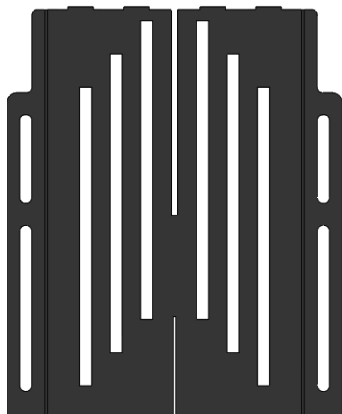

No:2 = 1 piece

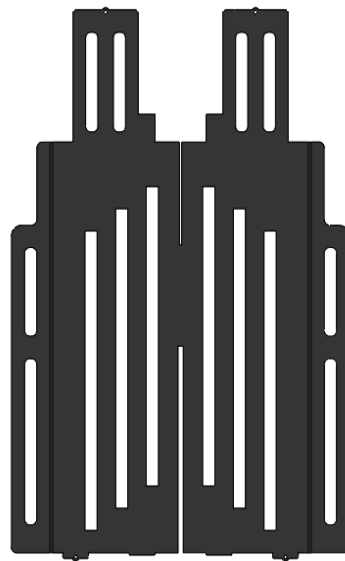

No:4 = 1 piece

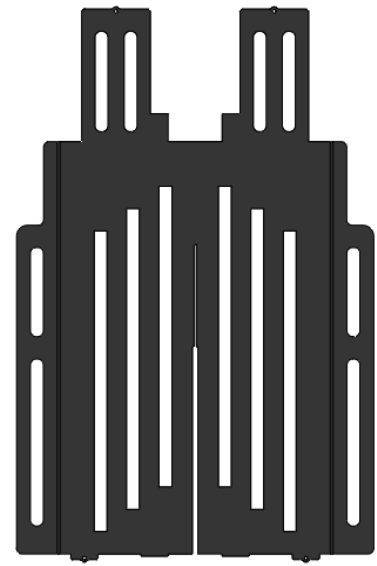

No:5 = 1 piece

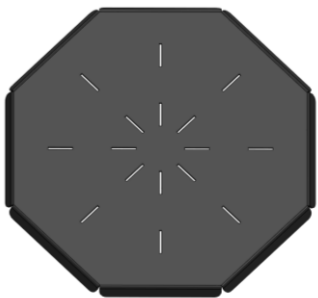

No:3 = 1 piece

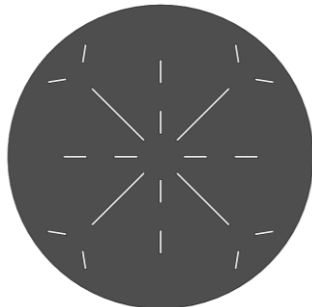

No:6 = 1 piece



No:7 = 4 piece

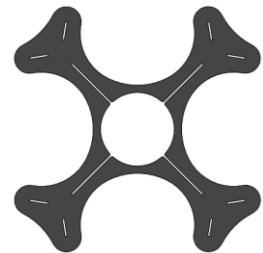

No:8 = 1 piece



Cotter pin =
12 piece

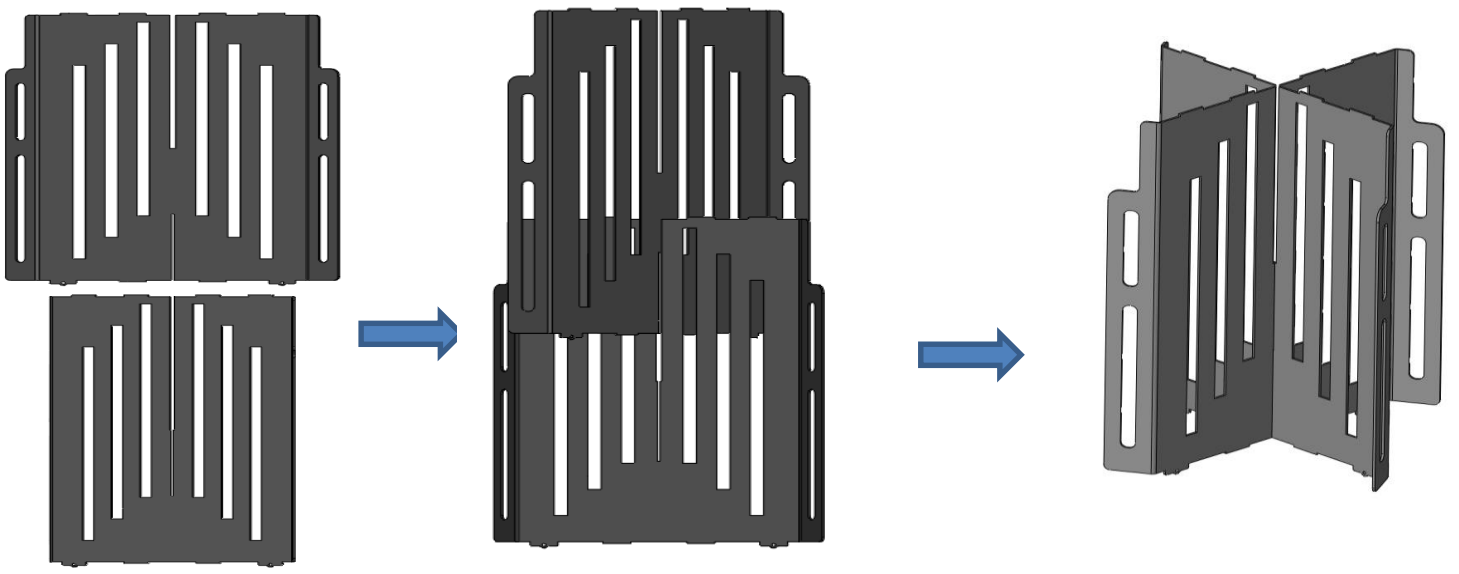

No:1 and No:2 + should put in into each other

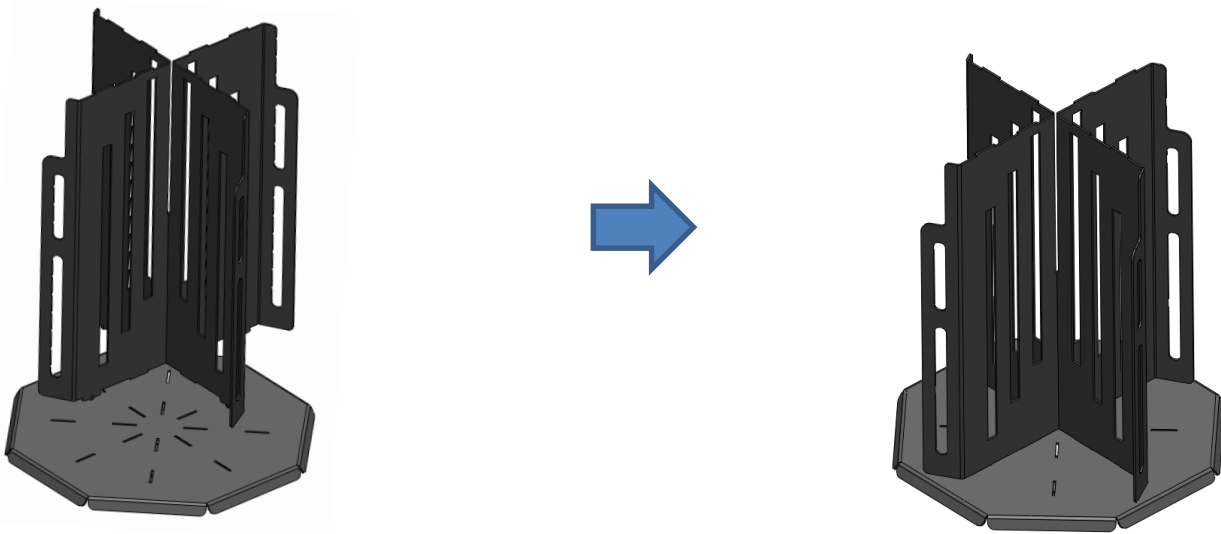

No:1 and No:2 after mounted , as next picture will be assembled with No:3

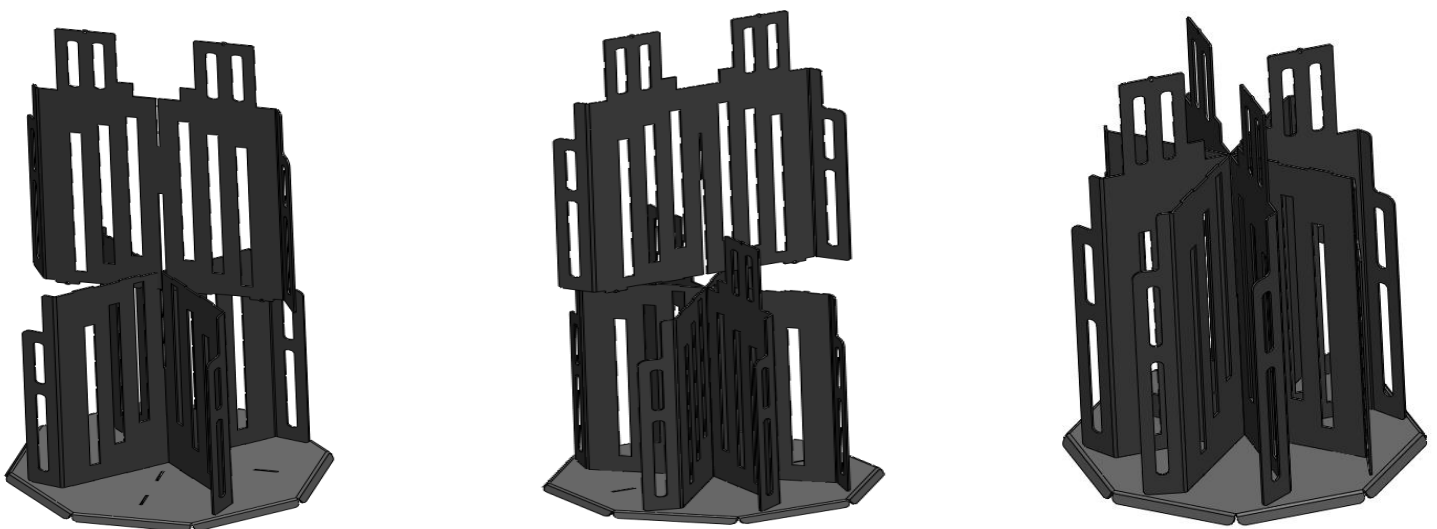

After mounted pieces (No:1, No:2, No:3) , by respectively No:4 and No:5 must be combined.

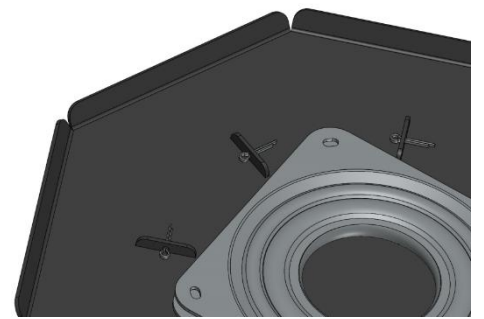
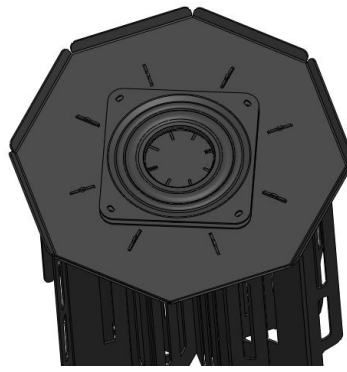
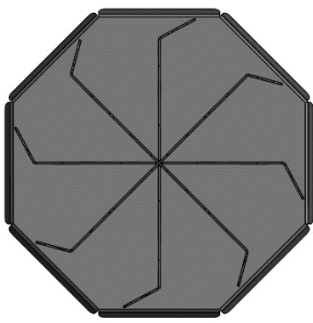

After the parts have been assembled, it must be inverted and attached to the cotterpin under all the edges.

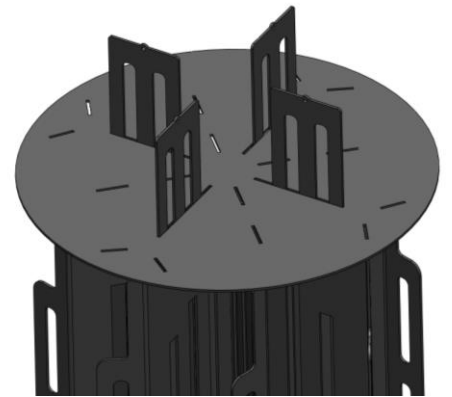
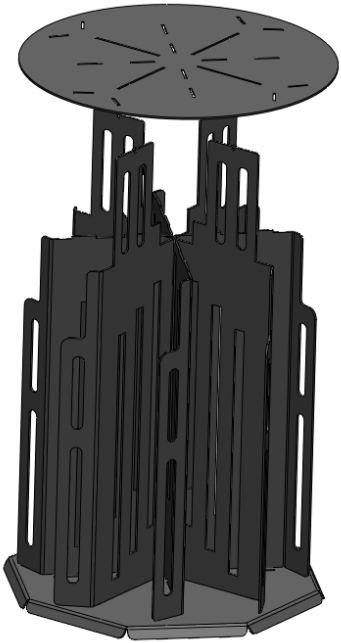

The next step installed with a cotterpin, can be combined with No:6

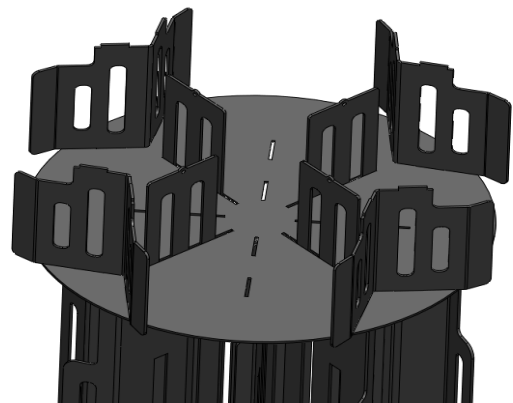
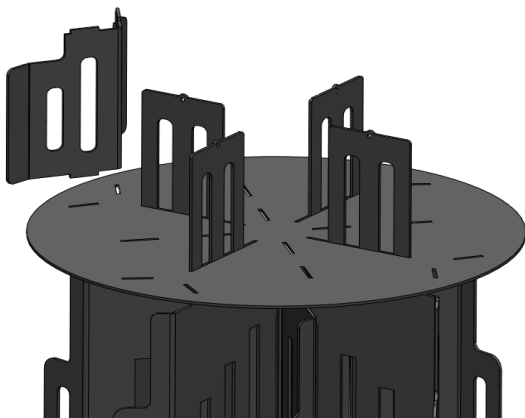

Side edges (No:7) should mounted to keep plates



Lock up plate part , top piece should be connected with (No:8) and mounted must be with cotter pin.

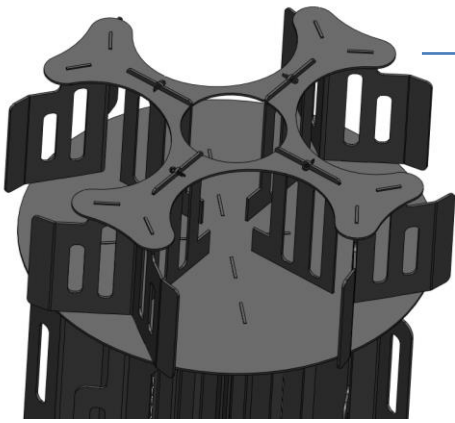

Please put metal bowl for spoon inside the round area.