

BLF207

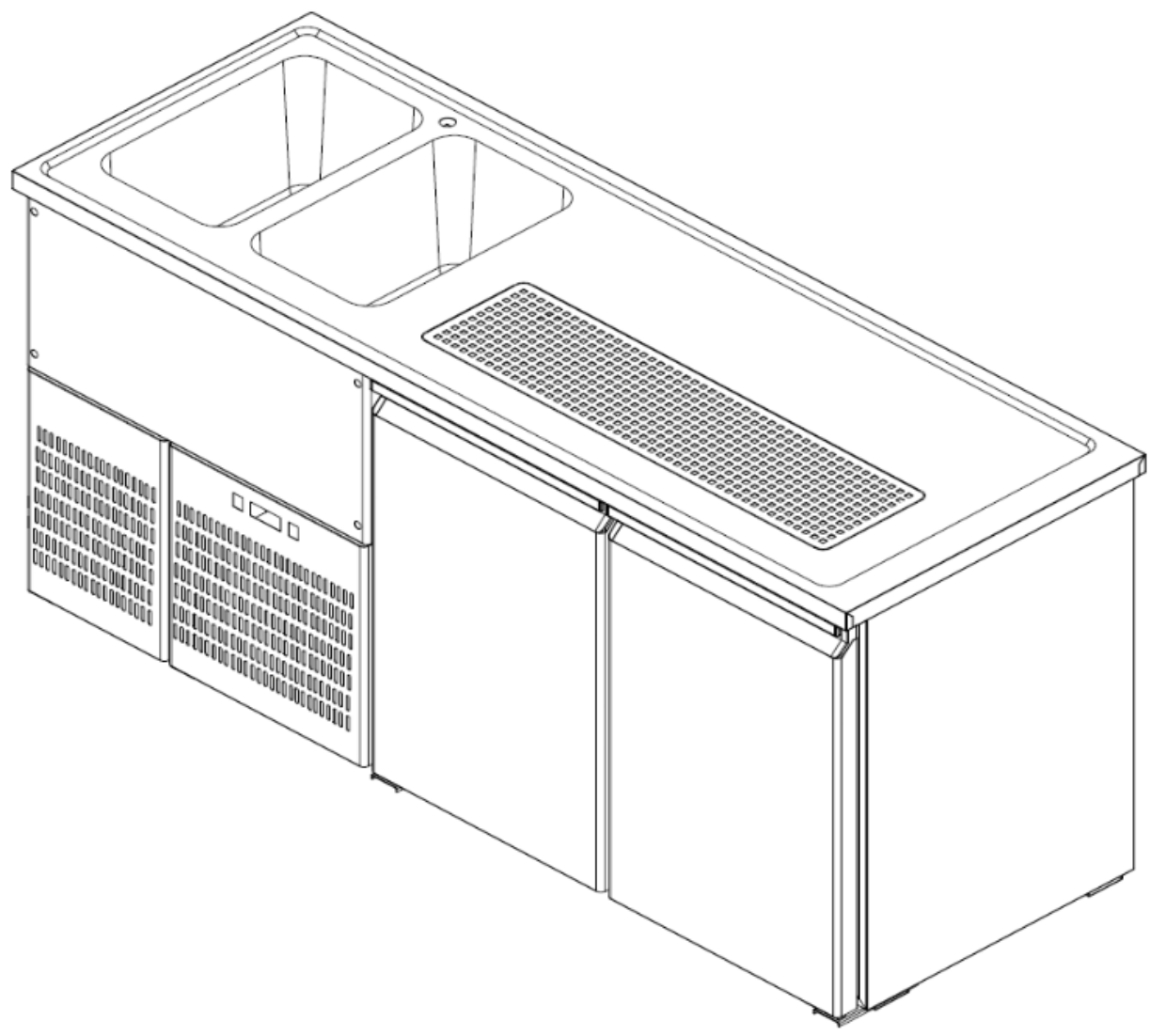

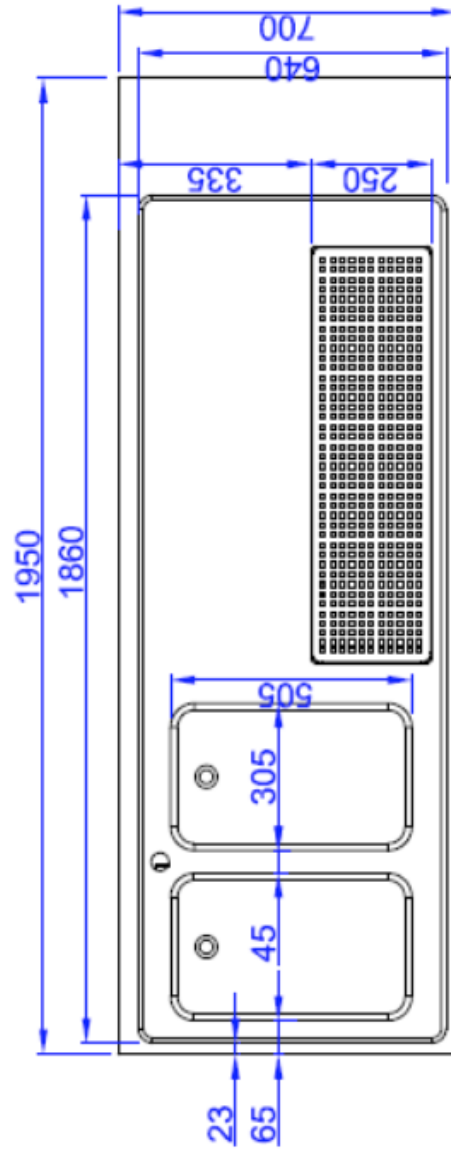
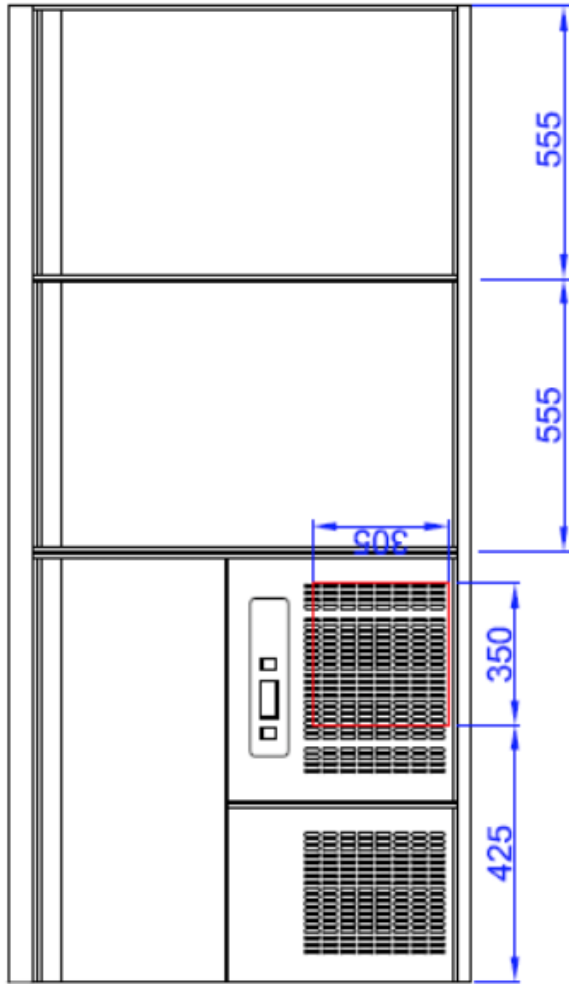
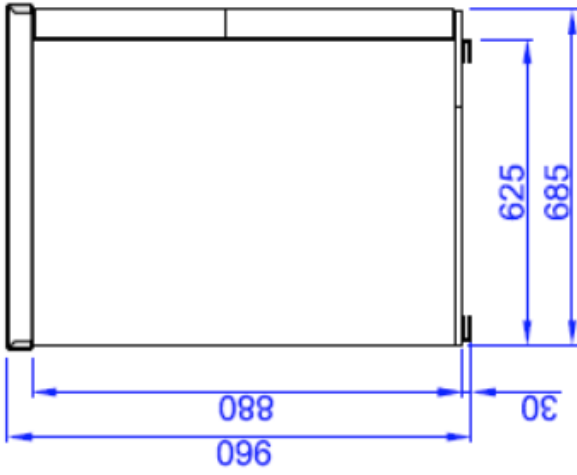

outside dimension: W 1950 x D 960 x H 700 mm
 inside dimension: W 990 x D 795 x H 565 mm

Außenmaße: B 1950 x T 960 x H 700 mm
 Innenmaße: B 990 x T 795 x H 565 mm

Explosionszeichnung/ Exploded view

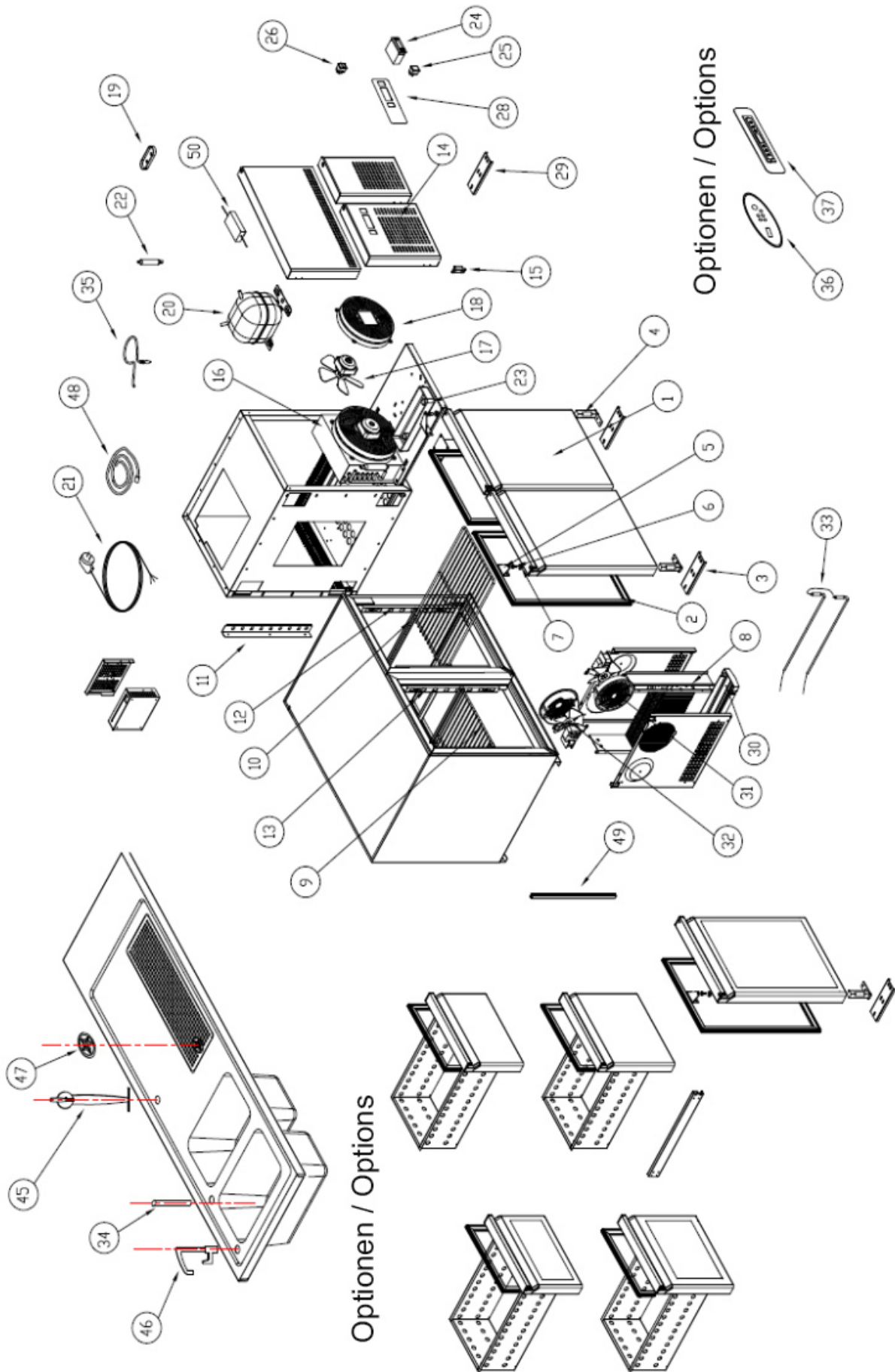

Explosionszeichnung SBEF12 / Exploded view SBEF12

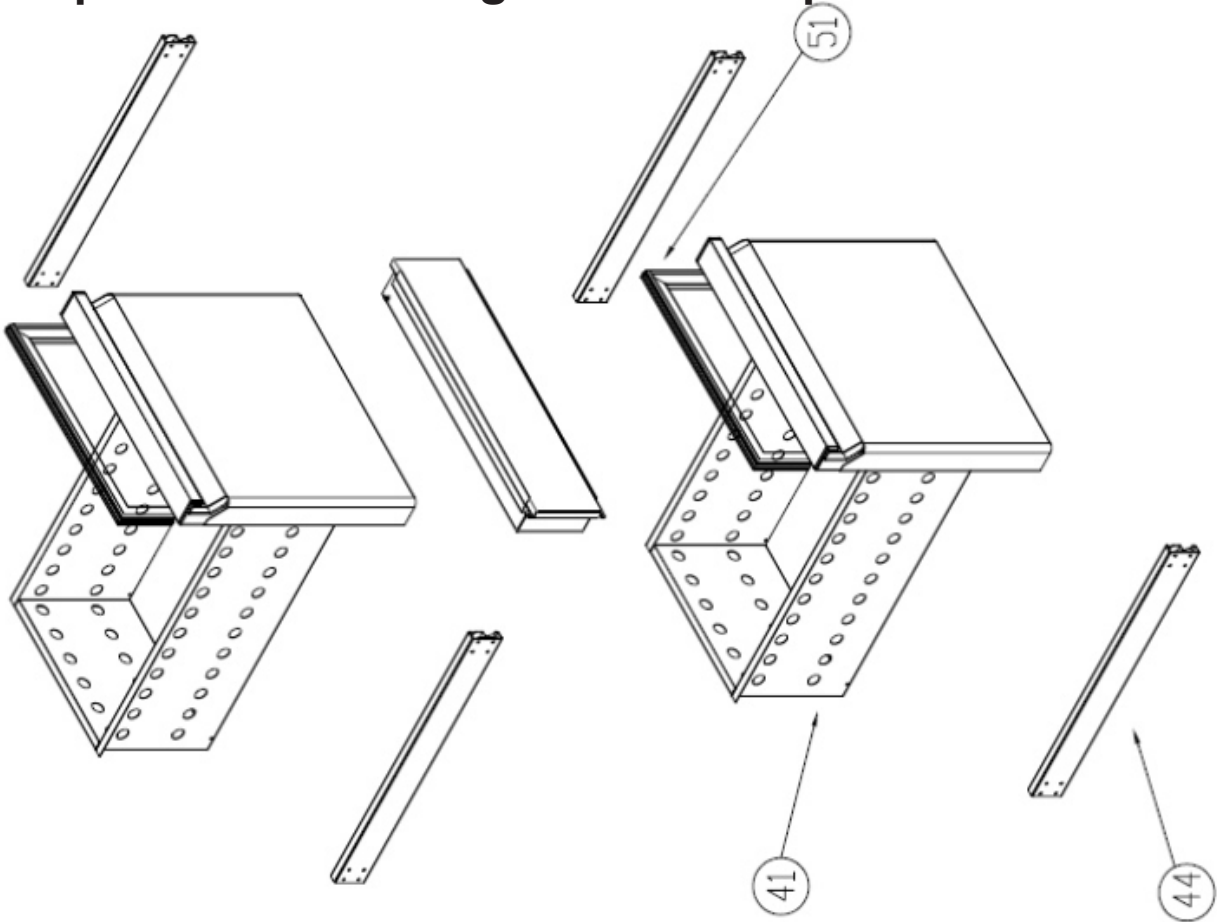

Explosionszeichnung SBGF12 / Exploded view SBGF12

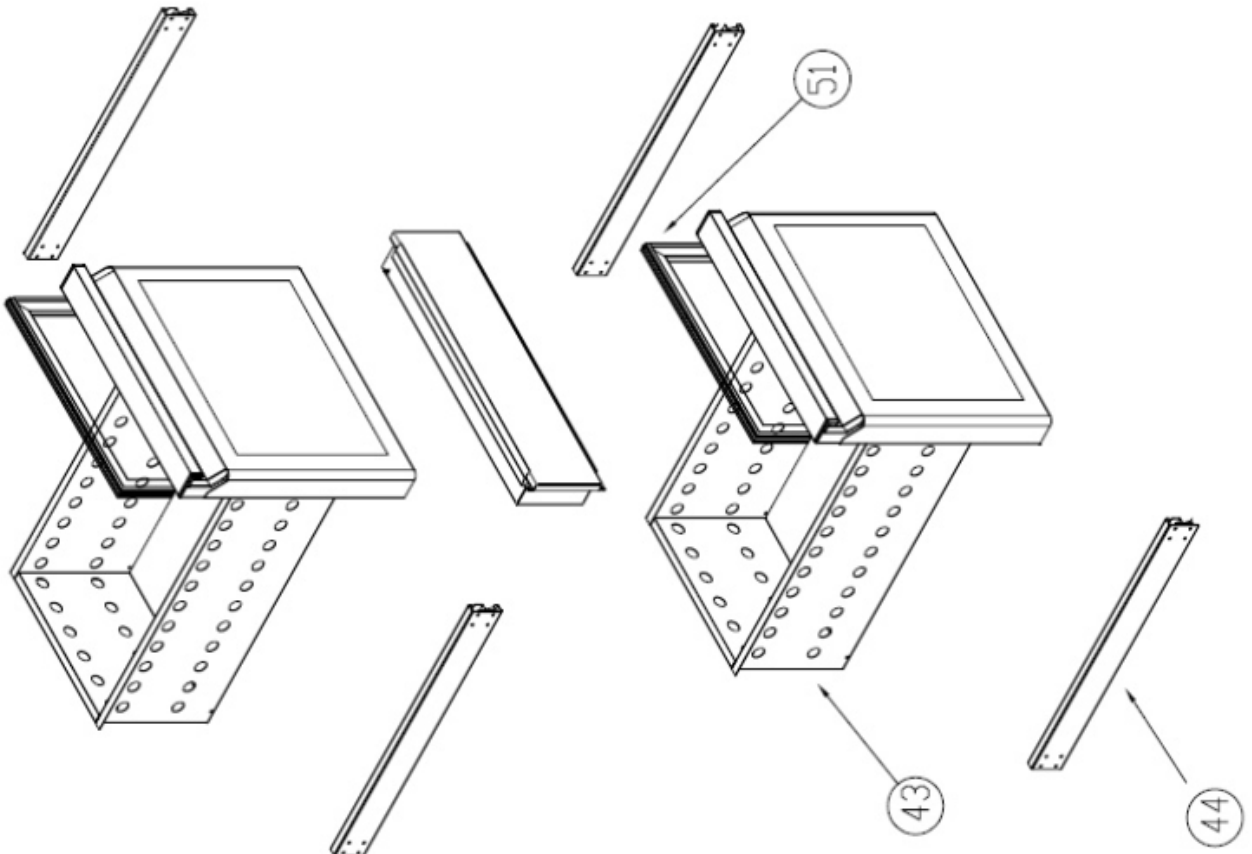

Explosionszeichnung SBEF13 / Exploded view SBEF13

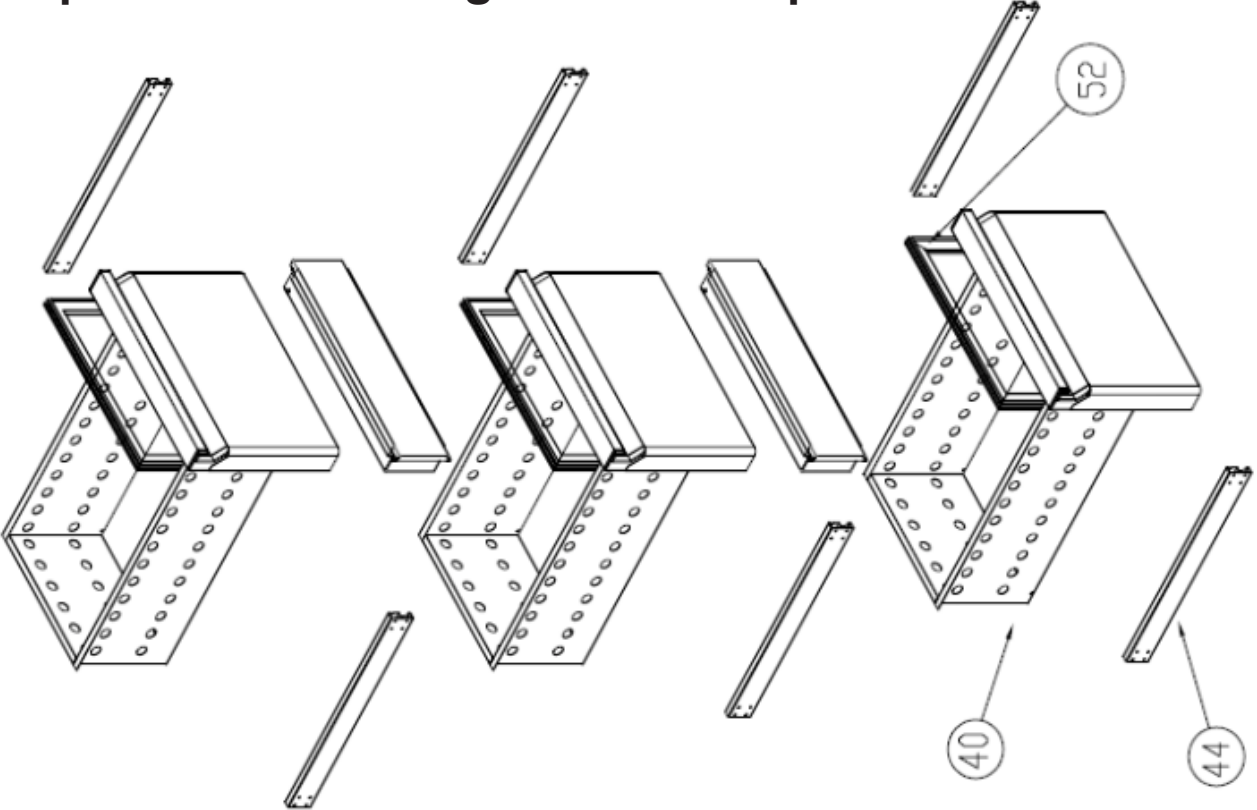

Explosionszeichnung SBGF12 / Exploded view SBGF13

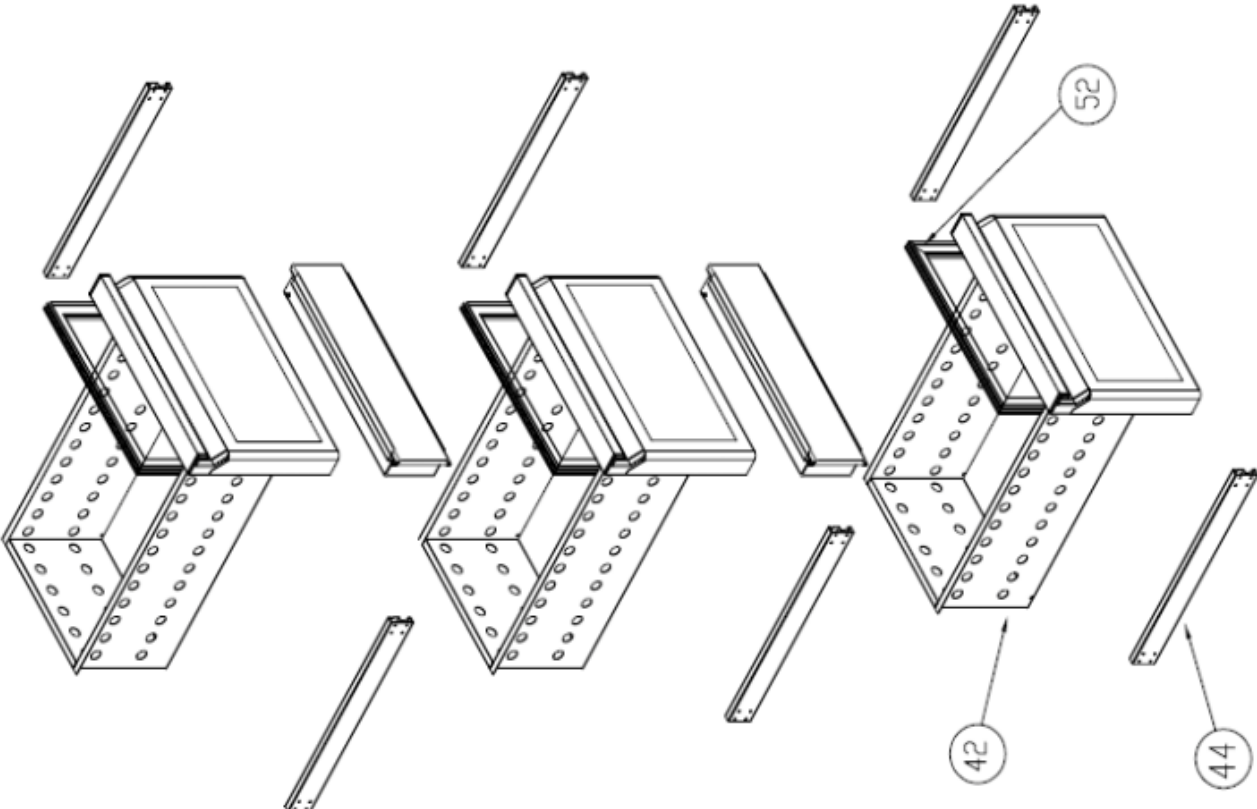

Explosionszeichnung Edelstahltür / exploded view stainless steel door

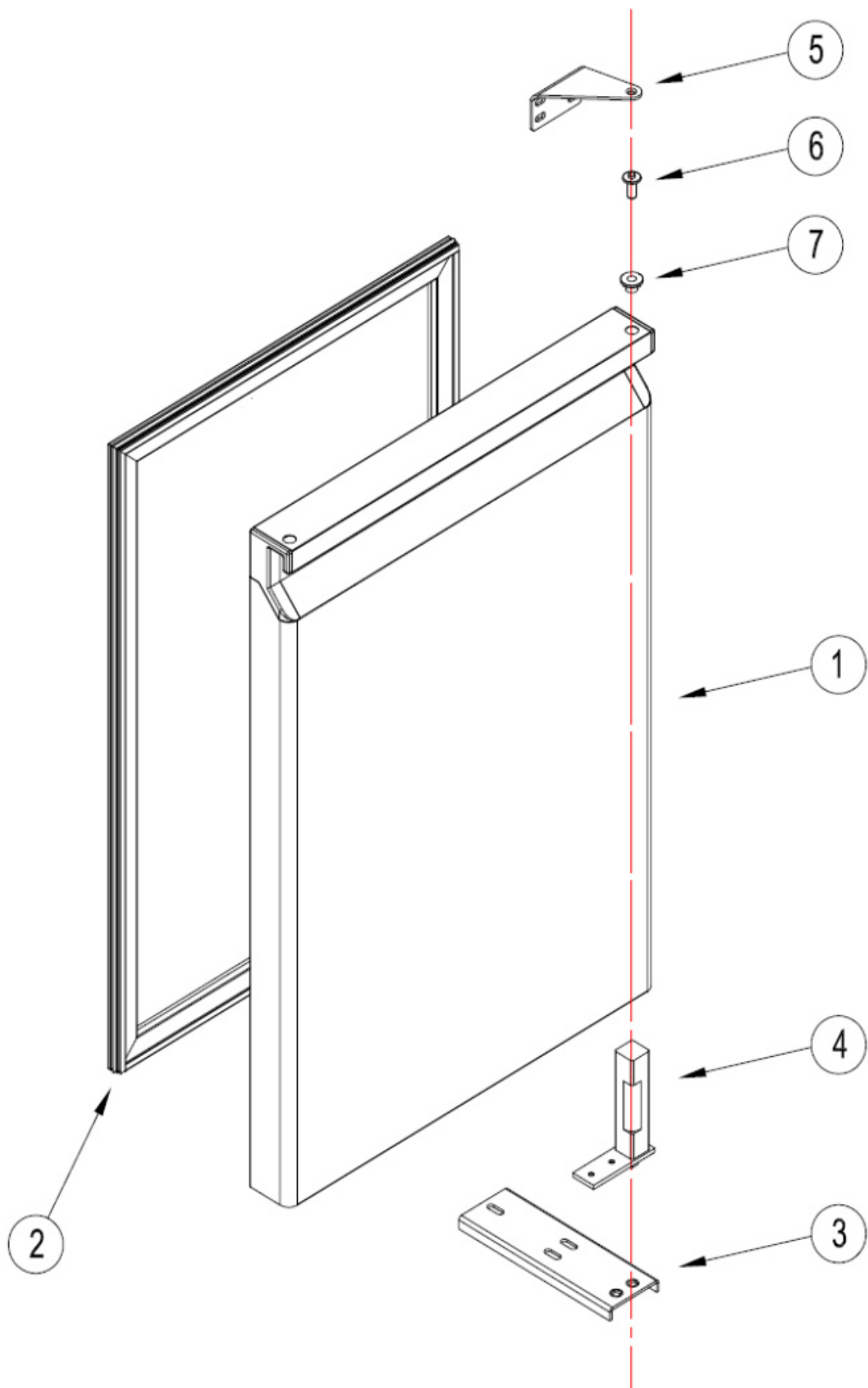

Explosionszeichnung Glastür / Exploded view glass door

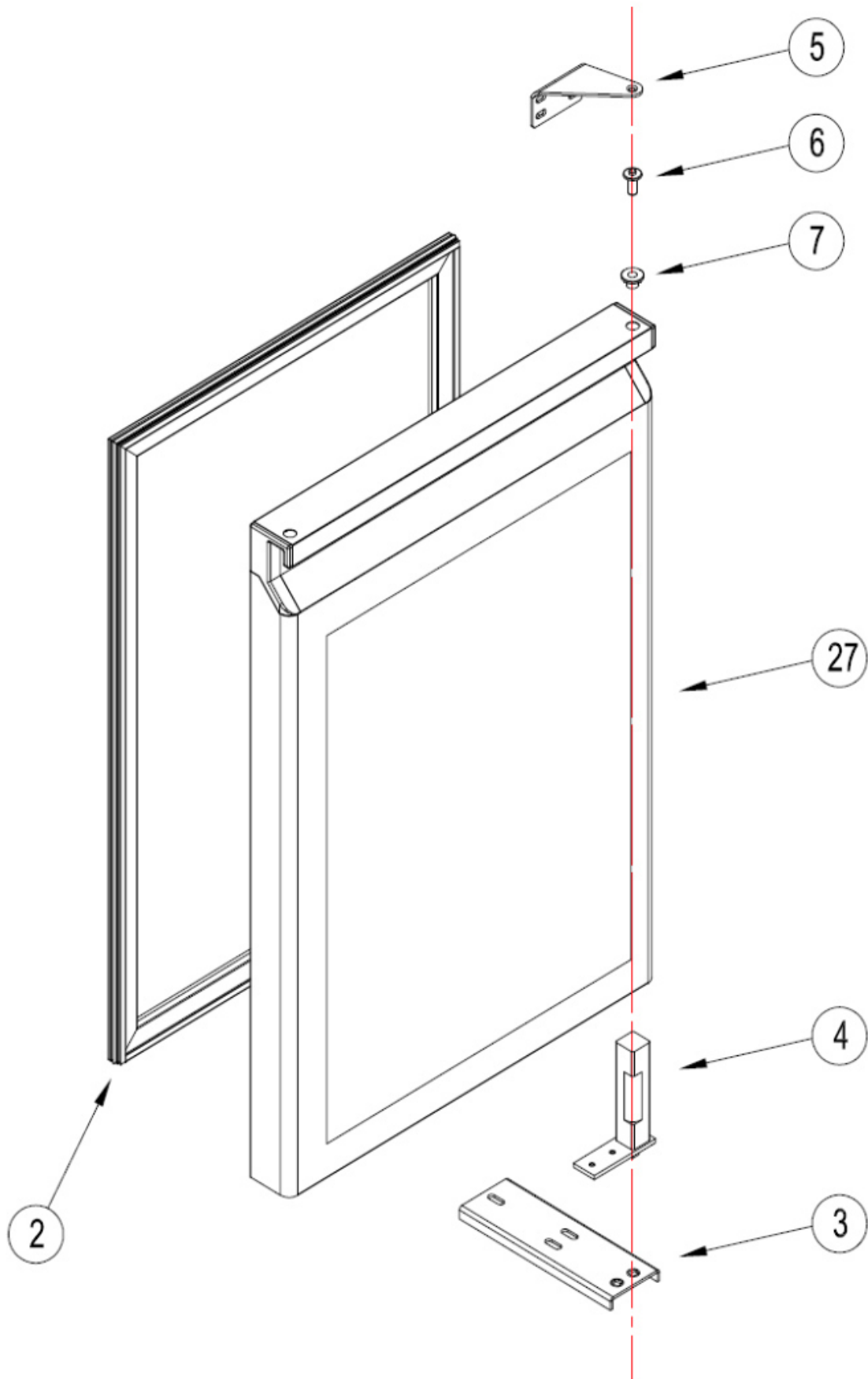

Explosionszeichnung Kühlung / Exploded view cooling

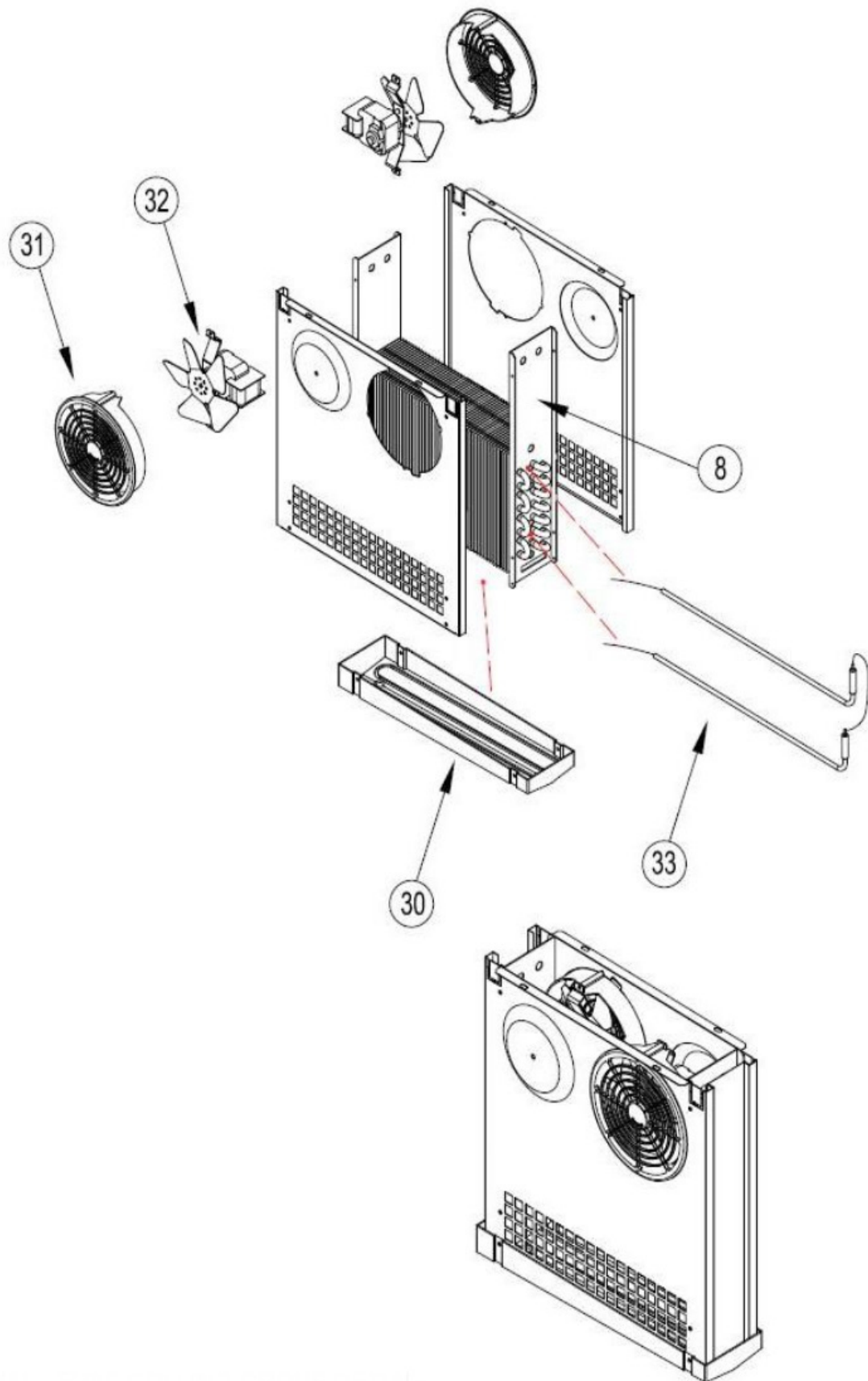

Liste der Einzelteile/ Spare parts list

NO	ARTIKEL NO	NAME EINZELTEIL	MATERIAL NAME	Menge
1	01A01KA141	TÜR	DOOR	2
2	A00CO125	TÜRDICHTUNG	DOOR GASKET	2
3	30080007	SCHARNIER UNTEN	LOWER HINGE BRACET	2
4	B02ME100	GERADES SCHARNIER+TEILE	UPRIGHT HINGE AND PARTS	2
5	30080008	SCHARNIER OBEN	UPPER HINGE	2
6	B01ME104	SCHARNIERBOLZEN OBEN	UPPER HINGE PIM	2
7	B01ME103	SCHARNIER PLASTIK	HINGE PLASTIC	2
8	A00EV100	VERDAMPFER	EVAPORATOR	1
9	B01RF124	REGAL - KGN 540X405mm	SHELF-KGN 540X405	2
10	C17000226		SHELF GUIDE - 530mm	4
11	C06887009	REGALFUß - HINTEN	SHELF RACKET - BACK	2
12	C06887008	REGALFUß - VORNE	SHELF RACKET - FRONT	4
13	C06887007	REGALFUß - MITTE	SHELF RACKET - MIDDLE	2
14	C06887112	ÜBERDECKUNG	CANOPY	1
15	B01ME112	MAGNETE	MAGNET HINGES	2
16	A00KN100	KONDENSATOR	1/4 Hp CONDANSER	1
17	A00FA109	LÜFTUNGSMOTOR	10W-FAN MOTOR	1
18	A00EP101	KONDENSATORLÜFTER PLASTIK	CONDENSER FAN PLASTIC	1
19	B00TK100	ABDECKUNGSTÜTZE	PROP COVER	1
20	A00KO110	KOMPRESSOR - EMT 6160Z	COMPRESSOR--EMT 6160Z	1
21	B00FK100	STECKERKABEL	PLUG CABLE	1
22	A00DR100	TROCKNER	DRAYER	1
23	B01BH102	WASSERBOX	WATER BOX	1
24	A00DJ100	DIGITALES THERMOSTAT ZWEI STÜTZEN	DIGITAL THERMOSTAT TWO PROPESES	1
25	B00DU101	STROMSCHALTER	POWER SWITCH	1
26	B00DU102	AN-/ AUSKNOPF	ON - OFF SWITCH	1
27	01A01KA142	GLASTÜR	GLASS DOOR	2
28	A00DJ105	DIGITALES ETIKETT	DIGITAL LABEL	1
29	P30080009	ÜBERDECKUNGSSCHARNIER	CANOPY HINGE	1
30	B01BH101	VERDAMPERSCHALE	EVAPORATOR CUP	1
31	A00EP100	PLASTIKLÜFTUNGSSCHUTZ	PLASTIC FAN PROTECTION	2
32	A00FA102	VERDAMPFERLÜFTUNGSMO- TOR	EVAP FAN MOTOR	2
33	B00REZ116	200 W WIDERSTAND	200W RESISTANCE	1
34	B00MU101	ÜBERLAUFSCUTZ	OVERFLOW DISCHARGER	1
35	A00DJ102	STÜTZE	PROP	1
36	A00DJ103	HAUPTPLATINE	MOTHERBOARD	1

Liste der Einzelteile/ Spare parts list

NO	ARTIKEL NO	NAME EINZELTEIL	MATERIAL NAME	Menge
37	A00DJ120	DIGITALE TOUCH-STEUERUNG	TOUCH CONTROL DIGITAL	1
38	A00C0127	1/3 SCHUBLADEN DICHTUNG	1/3 DRAWERS--GASKET	6
39	A00C0128	1/2 SCHUBLADEN DICHTUNG	1/2 DRAWERS--GASKET	4
40	SBEF1313	1/3 SCHUBLADENBLOCK	1/3 DRAWERS	6
41	SBEF1212	1/2 SCHUBLADENBLOCK	1/2 DRAWERS	4
42	SBGF1313	1/3 SCHUBLADENBLOCK GLAS	1/3 DRAWERS--GLASS	6
43	SBGF1212	1/2 SCHUBLADENBLOCK GLAS	1/2 DRAWERS--GLASS	4
44	A00CK101	SCHUBLADENSCHIENE	DRAWER RAIL	
45	B00BB100	BIERTURMSET	BEER TOWER SET	1
46	B00MU100	WASSERHAHN	SINK FAUCET	1
47	B00BB101	GLASSCHEIBE	GLASS WASHER	1
48	A00DJ109	STÜTZE	PROP	1
49	A00LA116	LED LAMPE	LED LAMP	2
50	B00LA111	TRAFO LED	TRANSFORMER LED	1
51	01A01EV270	BIERTHEKEN KOMBINATION 2 TÜREN	COUNTER REF EVAP GROUP 2 DOORS	1

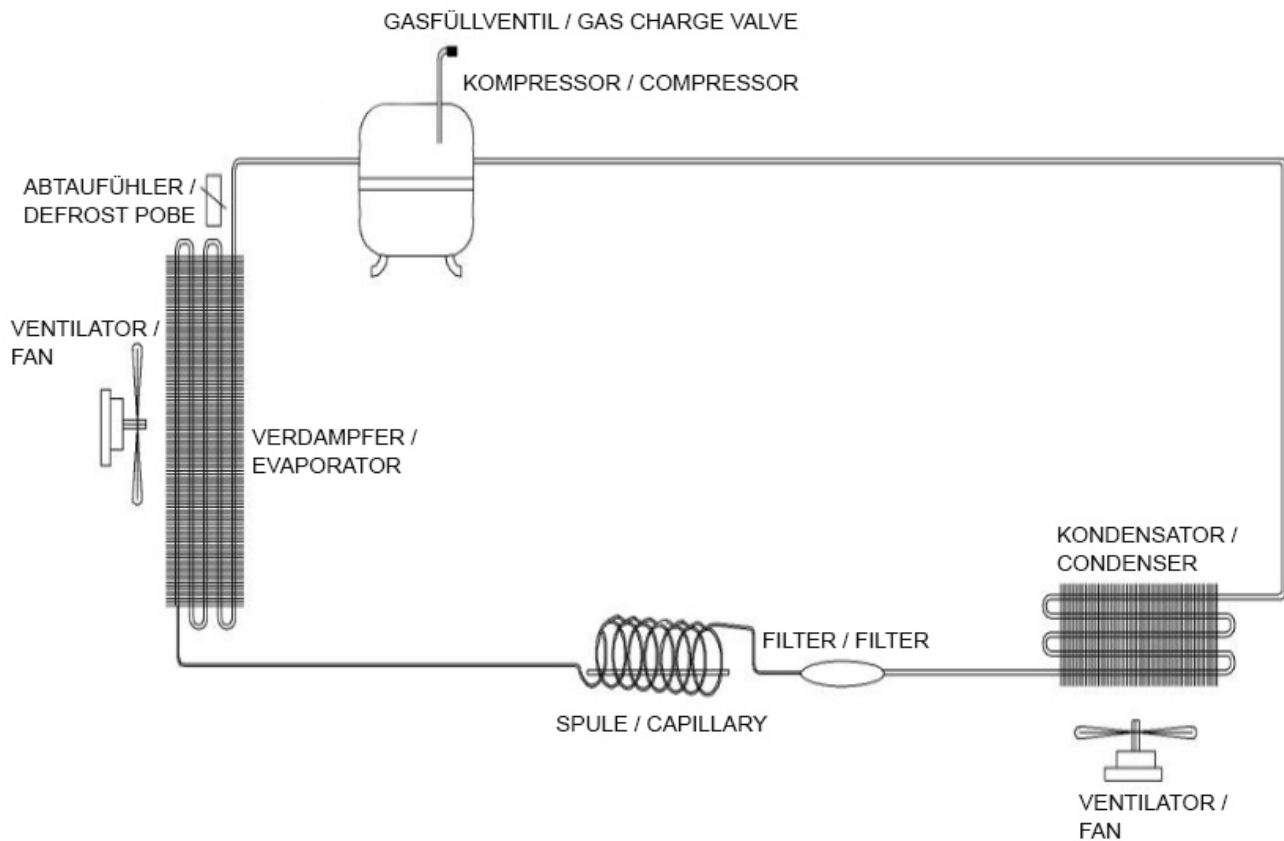

ELEKTRISCHES SCHEMA KÜHLUNG / ELECTRICAL SCHEMA REFRIGERATOR

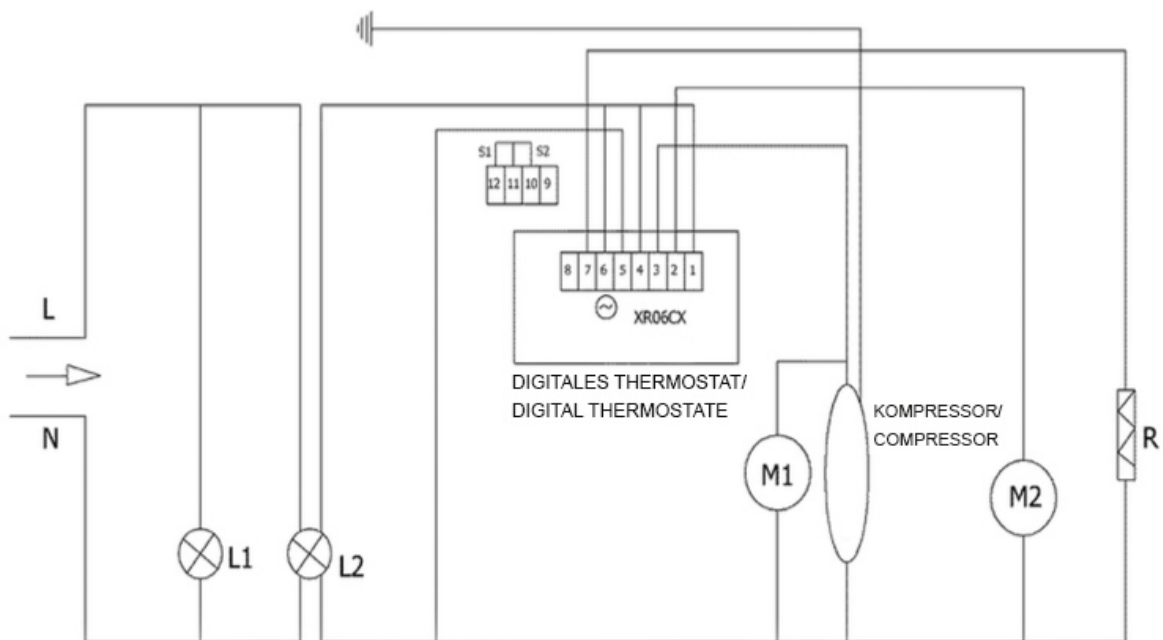

XR06CX: DIGITALES THERMOMETER / DIGITAL THERMOMETER L1: STROMLAMPE / POWER LAMB
M1: KONDENSATORLÜFTUNGSMOTOR / KONDENSER FAN MOTOR L2: AN-/ AUSSCHALTER
M2: VERDAMPFERLÜFTUNGSMOTOR / EVAPORATE FAN MOTOR R: VERDAMPFERWIDERSTAND / EVAPORATE RESISTANCE
S1: RAUMSONDE / ROOM PROB
S2: VERDAMPFERSONDE / EVAPORATE PROB