

ICY wine cooler manual

Model:WDA2 WDA4 WDA6



Wine Dispenser

General Operating Instructions

Remove all external and internal packaging from your appliance. Be sure that all parts have been included before discarding any packaging materials. You may want to keep the box and packing materials for use at a later date.

READ ALL INSTRUCTIONS BEFORE USING THIS APPLIANCE

- Save these instructions -

SERVING WINES

Storing wines at the proper temperature is important. To preserve them as long as possible wine should be stored at approximately 55° Fahrenheit. However, the chart below suggests the optimal drinking temperature for the different styles of wine.

°C	°F	Wine Style
19	66	Armagnac, Brandy, Cognac
18	64	Full Bodied Red Wines, Shiraz
17	62	Tawny Port
15	59	Medium Bodied Red Wines
14	57	Amontillado Sherry
13	55	Light Bodied Red Wines
12	54	Full Bodied White Wines
11	52	Medium Bodied White Wines
10	50	Rosé, Light Bodied White wines
9	48	Vintage Sparkling
8	46	Fino Sherry
7	45	Non Vintage Sparkling

TABLE OF CONTENTS

IMPORTANT SAFETY INSTRUCTIONS.....	4
ELECTRICAL SAFETY INFORMATION.....	5
FEATURE DESCRIPTION.....	6
SPECIFICATIONS.....	7
INSTALLATION INSTRUCTIONS.....	8
DISPENSER OPERATION.....	9
FRONT PANEL COMMANDS.....	10
CARE & MAINTENANCE.....	11
TROUBLESHOOTING.....	12
DISPENSING DIAGNOSIS.....	13
CIRCUIT DIAGRAM.....	14

IMPORTANT SAFETY INSTRUCTIONS

To reduce the risk of fire, electrical shock, or injury when using your appliance, follow these basic precautions:

- Read and follow all instructions before use.
- Do not use if supply cord is damaged. If damaged, it must be replaced by the manufacturer or a similarly qualified person in order to avoid hazard.
- Ensure the appliance is always unplugged before cleaning.
- To clean, use only mild detergents or glass cleaning products. Do not use harsh detergents or solvents.
- Do not store food in cabinet.
- Keep appliance away from any heat source or direct sunlight.
- For stability, the appliance must be placed on a solid, flat surface.
- Do not place any other appliance on top of the unit.
- The wine dispenser is an electrical appliance. To avoid injury or death from electrical shock do not operate the wine cooler with wet hands, while standing on a wet surface or in other wet conditions.
- When positioned or if moving the appliance, ensure that it is not set horizontally, positioned at an angle of more than 45°, or turned upside down.
- Never lift or carry the wine cellar by the cord.
- Keep the cord away from heated surfaces.
- Be sure to leave proper clearances on sides of appliance to allow for proper airflow and operating function.
- For indoor household use only. Any other use will void the warranty.
- For adult use only.
- Do not plug into the power socket before setup is completed.
- Always unplug an appliance from outlet when not in use. Never pull cord to remove plug from outlet. Grasp plug and pull to disconnect.
- Never allow children to operate, play with, or crawl inside the appliance.
- Never clean appliance parts with flammable fluids. The fumes can create a fire hazard or explosion.
- Do not store or use gasoline or any other flammable vapors and liquids in the vicinity of this or any other appliances. The fumes can create a fire hazard or explosion.

WARNING: Risk of child entrapment. Junked or abandoned appliances are still dangerous. **Before you throw away an old wine cellar/dispenser** take off the door and leave the shelves in place so that children may not easily climb inside, or take other action to ensure the cellar is harmless.

WARNING: Gas cartridge contents under pressure. Do not puncture or incinerate. Keep away from heat and out of direct sunlight. Keep away from sharp objects that could puncture chamber. Do not store in an enclosed vehicle. Do not discharge towards face or body. **KEEP OUT OF REACH OF CHILDREN.**

WARNING: The gas cartridge inflation pressure should not more than 12MPa.

ELECTRICAL SAFETY INFORMATION

 WARNING	
	ELECTRIC SHOCK HAZARD Disconnect electric supply from appliance before servicing. Replace all panels before operating. Failure to do so could result in death or electrical shock.

Electrical Cord

- Because of potential safety hazards under a certain condition, we strongly recommend against the use of an extension cord. However, if you still elect to use an extension cord, it is absolutely necessary that it will be a VDE LISTED 2-wire grounding type appliance extension cord with a 2-blade grounding plug and a 2-slot receptacle. The marked rating of the extension cord should be AC250V 16A

FEATURE DESCRIPTION

- The Wine dispenser keeps opened wines fresh from oxidization for weeks through use of noble gas such as nitrogen or argon.
- The refrigerated glass-door cabinet displays wines and dispenses from up to opened bottles .
- Quiet, high-output compressor system with automatic defrost maintains wine at the proper storing and serving temperature between 7°C and 18°C.
- The compact design with blue LED touch-buttons gives the modern attraction.
- NSF-approved plastic components and sanitary stainless steel spout keep your wines clean.
- Miniature stainless steel esectronic valves prevent any wine drip from the dispensing spout.
- A blue LED digital temperature controller allows you to set the desired temperature for white or red wines easily.

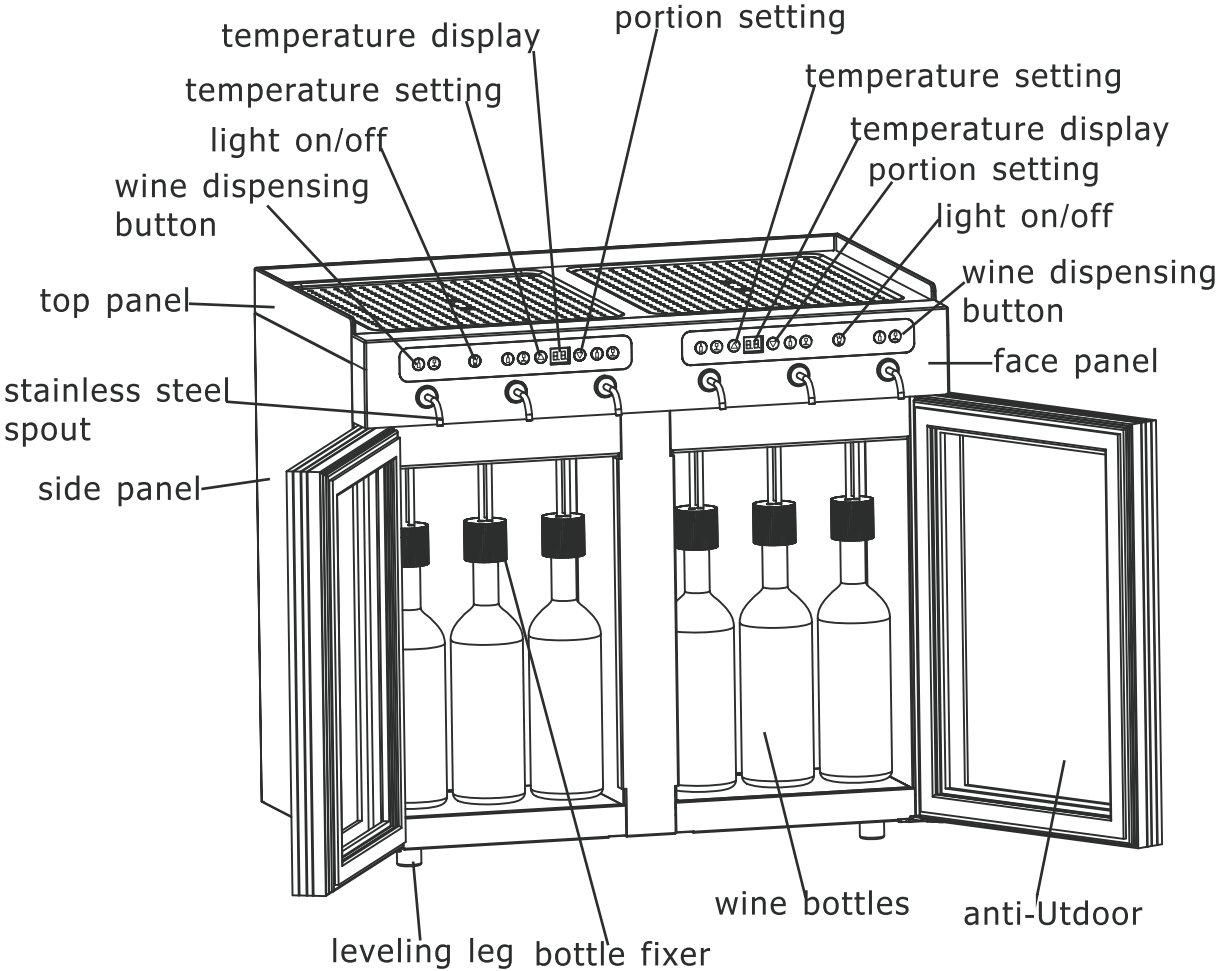



SPECIFICATIONS 85W/95W/100W

Model NO.	WDA2 WDA4 WDA6	
Rated Voltage	220~240V/50Hz	
Cooling Power	85W/95W/100W	
Refrigerant	R600a	
Protection Class	I	
Adjustable Temp. Range	7-18°C(45-65°F)	
Ambient Temp. Range	7-32°C(45-90°F)	
Bottle Capacity	2/4/6	
Maximum Bottle Shelf Life	30days	
Dimensions(in)WXDXH	WDA2	B.235 X H.572 X T.420mm
	WDA4	B.415 X H.625 X T.430mm
	WDA6	B.673 X H.624 X T.504mm

Note: Argon gas not included. Suitable standard argon gas cartridges are non-refillable and have a thread neck size of 0.5" in diameter and minimum length of 0.5". The cartridge must have a diameter not exceeding 1.75" and a length not to exceed 5.5".

INSTALLATION INSTRUCTIONS

 WARNING	
	<p>Always check wiring harness connections before initiating any test procedures.</p> <p>Disconnect electric power from the appliance before performing any maintenance or repairs.</p> <p>Voltage checks should be made by inserting meter probes beside the wires in the connector blocks with the electric power source on and the connector block plugged in.</p> <p>Resistance checks should be made on components with the electric power off and the connector block disconnected.</p>

Location

- This wine-dispenser is designed for free-standing installation only.
- It is recommended that this unit be kept in a location with an ambient temperature range of 7°C - 32°C. It is not intended for garage or basement installation.
- Place the unit in a properly ventilated location to prevent heat build-up generated by the refrigeration system. Failure to do so will prevent the unit from cooling properly, and may result in damage to unit components as well as its contents.
- Leave 12cm clearance on all sides.
- Use the adjustable legs to position the unit level.

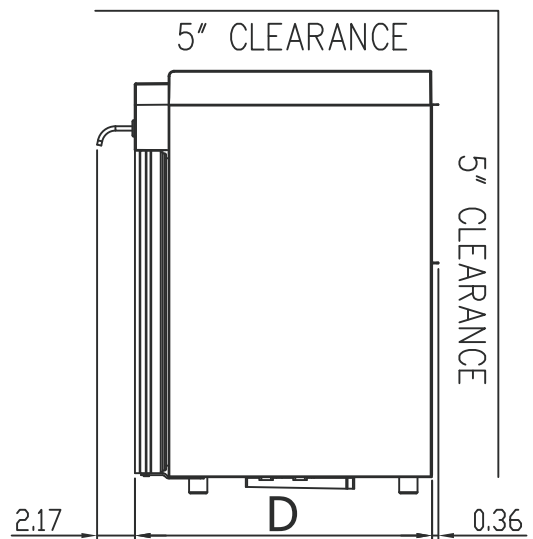
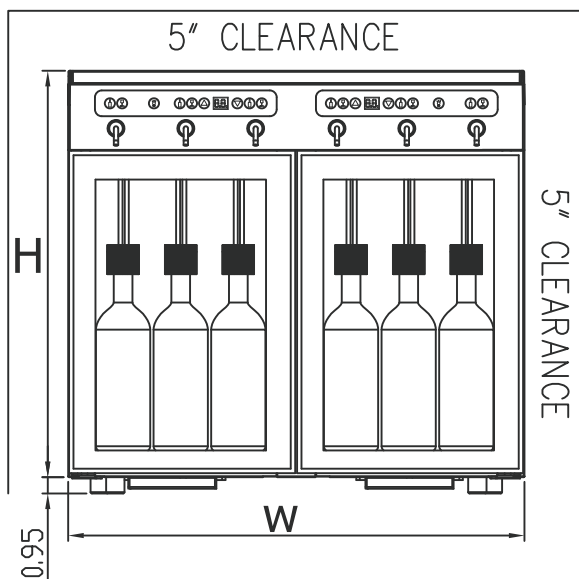

DISPENSER OPERATION

Once unit is positioned and plugged in, turn the power on.

Loading/Unloading Argon/Nitrogen/Inert Gas Cartridge

1. Boost up, open the upper back-panel. (See diagram, as shown at the arrow, picture 1.)
2. One hand grasp gas cartridge turn to certain angle in order to disboard empty gas bottle. (See diagram, as shown at the arrow, picture 2.)
3. Take the gas bottle/cartridge out of gripper antorsely. With one hand holding the decompression valve and with the other holding cartridge, unscrew the cartridge, take it away. (See diagram, picture 3.)
4. To insert new cartridge, first carefully line up the screw end of the cartridge to the redactor cartridge mouth and screw into place. (See diagram, picture 2.)

NOTE: It is normal for some gas to escape while screwing on cartridge. Makesure you screw cartridge in completely/tightly.

5. Check to make sure bottle/cartridge is secure.
6. Clip gas cartridge to cylinders clip. (See diagram, picture 1.1.)
7. Shut the upper back-panel down.
8. Open wine out valve.

Note: Two switches should not be opened at the same time.

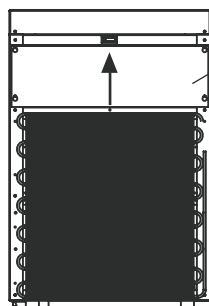

picture 1
(open the upper back-panel)

Back-panel
Gas cartridge
Decompression valve

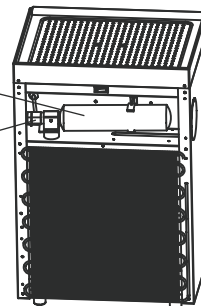

picture 1.1

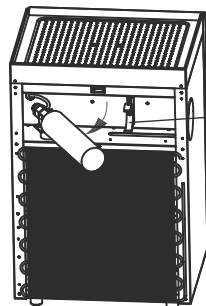

picture 2
(turn to the gas cartridge)

Cylinders clip

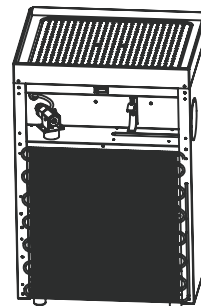

picture 3
(unload the gas cartridge)

FRONT PANEL COMMANDS









Display



During normal operating conditions, the display shows the value measured by the air regulation probe. In case of active alarm, the temperature flashes alternately to the code alarm.

Dispensing Wine



The wine dispenser features two sets of two dispensing buttons, each positioned directly above its corresponding wine bottle spout. The two dispensing button options are:

-  Press and hold the  button over the desired spout to begin dispensing wine into your glass. Wine will continue to be dispensed until the button is released.
-  Press the  button to dispense wine in 30ml increments. Press it once, display 1, dispense 30ml; press it twice, display 2, dispense 60ml; press it thrice, display 3, dispense 90ml; and so forth.
- The wine will be dispensed after waiting for one second when you press the  button.
- How to reset 30ml portion: The factory 30ml portion can be reset by the user. Press  twice and "H2" is displayed and then press  then the digit starts blinking, press up key  or down key  to increase or decrease the portion other than 20ml.



Other parameters A1,A2,A3 and A4

These parameters are used to calibrate the quantities of wine served on each faucet. For example, for a dose adjusted to 20 ml H2, A1 if you increase the value of the amount to be released on the first tap will be greater than 20ml. We advise you not to change the factory settings on these 4 advanced settings.

Temperature setting

The temperature display will show the current temperature inside the unit. When you need to set 7~18°C, please press the  button once the display shows "H1" and the displayed temperature starts to flash. While the temperature display starts to flash, use the  or  buttons to select your desired temperature.

LED Light on/off

When you press the button of left lamp down  and the first, the LED light in the left refrigerator will be on. When you press  it the second, the LED light in the left refrigerator will be off.

Attaching/Removing Wine Bottles

1. Fix the bottle to tubing.
2. Turn/screw tubing connection until its tight on the bottle.
3. Open the control valve to allow wine out and check to see if gas leakage will occur. (Reconnect tighter if needed so gas does escape.)
4. Place wine fully in refrigerated cabinet and close door.

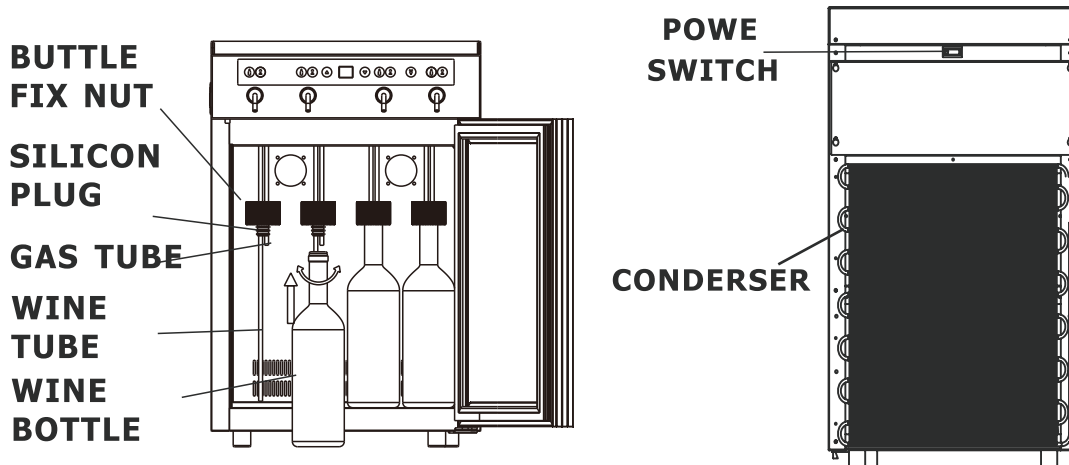



CARE & MAINTENANCE

IMPORTANT: Always unplug your wine dispenser before cleaning or performing maintenance. Nerve use harsh cleansers or scouring pands to clean any part of the wine dispenser.

Cleaning

To clean the bottle fixer and solenoid valve:

- Fill a bottle with clean warm water and place the bottle-fixer onto the bottle.
- Press and hold the  button to dispense the warm water.
Press portion button  5 times and then hold it until the display shows "CL" and flashes, the automatic clean will start.
- Continue to dispense and flush the system until dry gas comes from the spout.

TROUBLESHOOTING

Dispensing System

Complaint	Possible Causes	Response
One canister only dispensing 1 or 2 bottles, gas leaking/ escaping	<ul style="list-style-type: none"> a. Canister gasket unaligned, bad or missing b. Canister not tightened c. Gas tube broken d. Gas tube not tightened at the regulator or valve e. Regulator leak f. Gas valve stuck open g. Bottle not tightened 	<ul style="list-style-type: none"> a. Align, change or install the gasket b. Turn the canister clockwise all the way c. Change the gas tube d. Check for these connections e. Check for gas escaping at regulator f. If gas continues to escape from the gas tube, check for gas valve, wirings. g. Check for plug/fixer
Unit not dispensing	<ul style="list-style-type: none"> a. Inert gas empty b. Defective pressure regulator c. Bottle neck not tightened or defective plug d. Defective gas solenoid valve or incorrect wiring e. Defective wine solenoid valve or incorrect wiring f. Incorrect or loose wirings, defective power board or control board. 	<ul style="list-style-type: none"> a. If all spouts don't dispense wine, check for canister pressure gauge, or turn the canister slightly counter-clockwise to see if any gas escaping and then turn clockwise to tighten; then check for gas leaking as above. b. If all spouts don't dispense wine and the canister has pressurized gas, check the regulator. c. Press button to check if gas escaping from the plug and fixer d. Press button to check if gas escaping out of the gas tube e. Switch the questionable valve to a good spout and check if the problem still exists f. Check all wirings and connections
Dispensing interrupted or slow	<ul style="list-style-type: none"> a. Inert gas pressure low b. Gas tubes kinked, twisted c. Bottle neck not tightened d. Gas solenoid valve restricted e. Wine solenoid valve restricted 	<ul style="list-style-type: none"> a. If all spouts dispense wine slow, check pressure and change a new canister b. Press button to see if gas escaping out of the gas tube very slowly c. Check for bottle plug and fixer if gas escaping d. Remove bottle, press button to check if gas escaping out of gas tube e. Switch the valve to a good spout to check
Wine spurting or spitting	<ul style="list-style-type: none"> a. Wine tube restricted b. Bottle near empty and too much gas in the bottle c. Gas pressure too high d. Wine solenoid valve dirty 	<ul style="list-style-type: none"> a. Check any restrictions b. Change a new bottle c. Replace pressure regulator d. Clean solenoid valves
Wine dripping	<ul style="list-style-type: none"> a. Solenoid valve seat leak b. Spout loose 	<ul style="list-style-type: none"> a. Check for debris if constant dripping; use warm water to flush the system b. Push the spout to tighten if intermittent dripping
	<ul style="list-style-type: none"> a. Wine tube leak b. Spout loose c. Empty bottle 	<ul style="list-style-type: none"> a. Check for wine tube b. Push the spout to tighten c. Change bottle
Wine divided	<ul style="list-style-type: none"> a. Debris in spout 	<ul style="list-style-type: none"> a. Clean out debris
Too much bubble	<ul style="list-style-type: none"> a. Inert gas pressure high 	<ul style="list-style-type: none"> a. Replace pressure regulator

Cooling System

Complaint	Possible Causes	Response
Unit not running	a. Power cord unplugged b. Power switch off c. No power to the outlet d. Incorrect and loose wirings	a. Check for power cord b. Turn on the switch (it lights) c. Check for power at the outlet and fuse d. Check for wirings and connections at power switch and power board; power switch itself
Unit running high temperature or continually	a. Improper Door seal b. Ambient temperature high	a. Check for door opening and gasket b. Check for installation location
Unit running high temperature	a. Setting too high b. Temperature sensor touching the cold panel	a. Lower temperature setting b. Displaying temperature is correct but cabinet temperature is high
Unit running low temperature	a. Unit Iced b. Power board fault c. Display/control board fault	a. Unplug unit to defrost b. Change a new board c. Change a new board
Not cooling but compressor running	a. Bad evaporator air flow	a. Check for restriction
Unit running noisy	a. Installation area not firm b. Any screws, nuts and metal parts loose	a. Check for level and flat b. Check for noise sound source if coming from fan mount, compressor mount and tubing loose

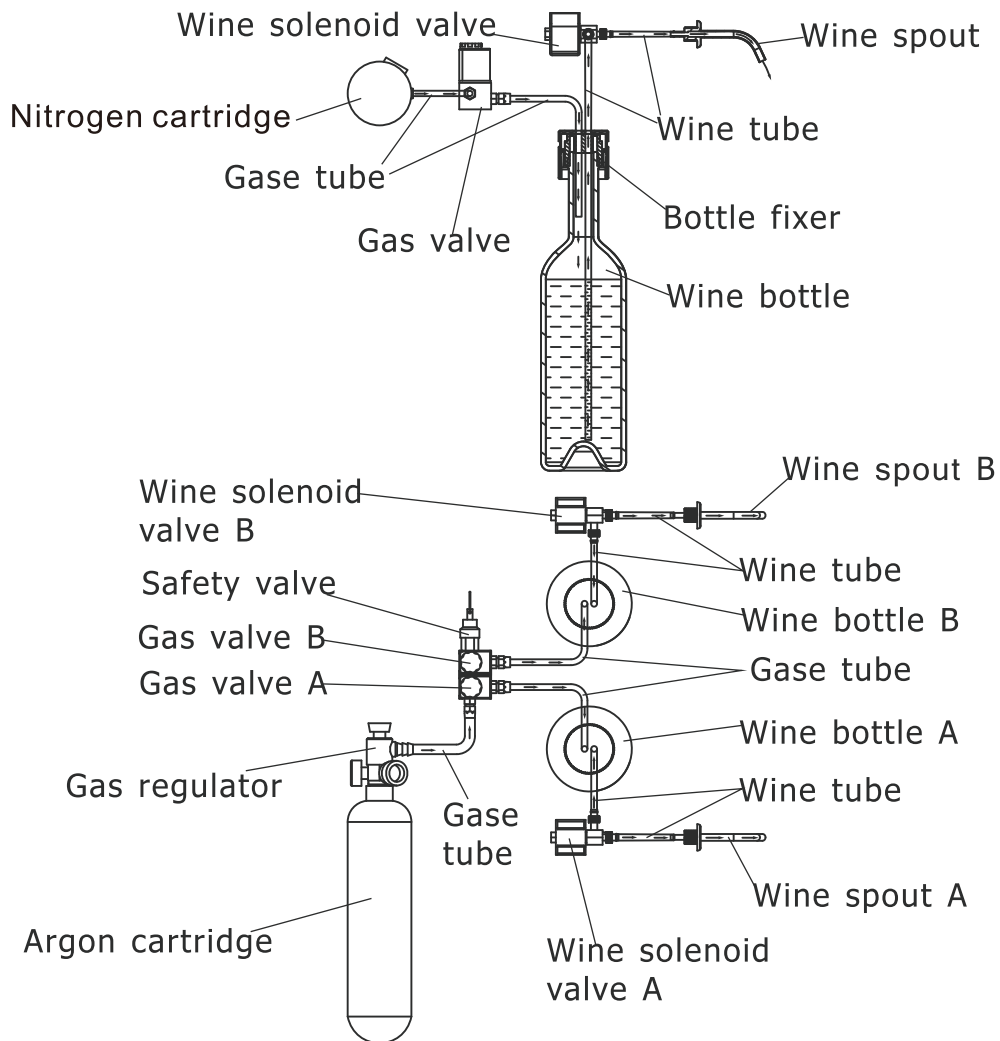

CIRCUIT DIAGRAM

