



BACK-BAR - MERCHANDISER REFRIGERATORS -

Service & Installation Manual





CONTENTS

1 GENERAL INFORMATION 3

2 SAFETY PRECAUTIONS 3

3 SERIAL DATA PLATE..... 4

4 RECEIVING AND INSPECTING THE EQUIPMENT 4

5 INSTALLATION 4

 5.1 Location..... 4

 5.2 Uncrating..... 5

 5.3 Ventilation..... 5

 5.4 Leveling 6

 5.5 Sealing Case to Floor 6

 5.6 Initial cleaning procedure 6

6 ELECTRICAL INSTRUCTIONS 6

7 STARTUP PROCEDURE 7

 7.1 Digital temperature controller (Carel) 7

 7.2 Start-up 9

8 OPERATION 9

 8.1 Temperature control adjustment 9

 8.2 Defrost control 10

8.3 Adjusting operation parameters..... 10

8.4 Digital temperature controller (Dixell)..... 12

8.5 Loading product 13

9 ACCESSORIES.....13

9.1 Shelving 13

10 MAINTENANCE, CARE AND CLEANING.....13

10.1 Cleaning procedure 13

10.2 Parts and Service..... 15

11 TROUBLE SHOOTING CHART.....15

1 GENERAL INFORMATION

Congratulations on your purchase. This refrigerator has been manufactured under strict quality controls and meets the high standards set by Infrico. Before shipping, each individual cabinet has been tested in order to assure a quality product. Furthermore, it has been produced with recyclable materials using an environmentally friendly process, making an active contribution to the preservation of our environment.

To get to know all the benefits of your new equipment, please read this instruction manual carefully before installing.



WARNING! Use this unit only for its intended purpose as described in this manual.

2 SAFETY PRECAUTIONS

When using electrical appliances, basic safety precautions should be followed, including the following:

- This refrigerator must be properly installed and located in accordance with this manual before it is used.
- Do not allow children to climb, stand or hang on the shelves in the refrigerator. They could damage the refrigerator and seriously injure themselves.
- Do not touch the cold surfaces in freezer compartments when hands are damp or wet. Skin may stick to these extremely cold surfaces.

- Do not store or use flammable products near the refrigerator.
- Unplug the refrigerator before cleaning and making repairs.



NOTE: We strongly recommend that any servicing be performed by a qualified technician.

3 SERIAL DATA PLATE

The serial data plate is a permanently affixed label which has important electrical and refrigeration data about your product, as well as the model and serial number. This label is located in the interior compartment on all standard models.

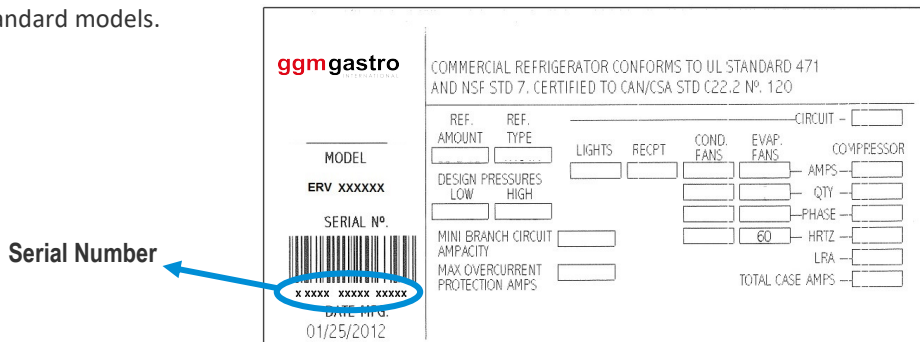

4 RECEIVING AND INSPECTING THE EQUIPMENT

- All Infrico products are factory tested for performance and are free from defects when shipped.
- When your equipment arrives, you should carefully inspect the unit for damage during delivery.
- If damage is detected, you should save all the crating material and make note on the carrier's bill of lading describing the damage. A freight claim should be filled immediately.
- If damage is subsequently noted during or immediately after installation, contact our customer care service.



NOTE: Infrico is not responsible for damage incurred during shipment.

5 INSTALLATION

5.1 Location

This unit is intended for indoor use only.

Be sure the location chosen for your unit must be able to provide good air circulation for most efficient refrigeration.

Avoid locations near heat sources such as stoves, ovens, fryers, and also direct sunlight where temperatures can reach extreme values. Besides, do not select a location in an area where temperatures may drop below 55°F or increase more than 90°F.

You should allow enough clearance between the unit and the side walls in order to make use of the stay open feature of doors at 120°. The doors must be able to open a minimum of 90° in order to make use of the maximum clear door width.

Furthermore, the floor at the final location must be strong enough to support the total weight of the cabinet plus the maximum product load. Also, it must be level and free of vibration. Reinforce the floor if necessary.

5.2 Uncrating

Back-Bar and Merchandiser ERC 110 are shipped on a wooden pallet in stretch wrapped material and wood crate. First remove the plastic cover and then unscrew the wooden frame.

Merchandiser ERC 180 is shipped on a wooden pallet in stretch wrapped material and a wood frame. First remove the plastic cover and then remove the screws on the wooden frame.

All packaging materials used are environmentally friendly and may be recycled or reused. Actively contribute to the protection of the environment by insisting on packaging recovery and removal methods that are environmentally friendly.



NOTE: We do not recommend laying the unit down on its front, side or back. However, you must be certain to allow the unit to remain in an upright position afterwards for at least 24 hours before plugging it in so that the compressor oil and refrigerant may settle.

5.3 Ventilation

To assure maximum operating efficiency, the equipment should be located where a continuous air supply can circulate around the cabinet. To maintain a proper air flow, a minimum of 30" on the front of the unit must be provided.

Restricting the air supply will generate an excessive heat load on the condensing unit and adversely affect its operating efficiency. Do not at any time obstruct the grill area in the front of the cabinet in any way.

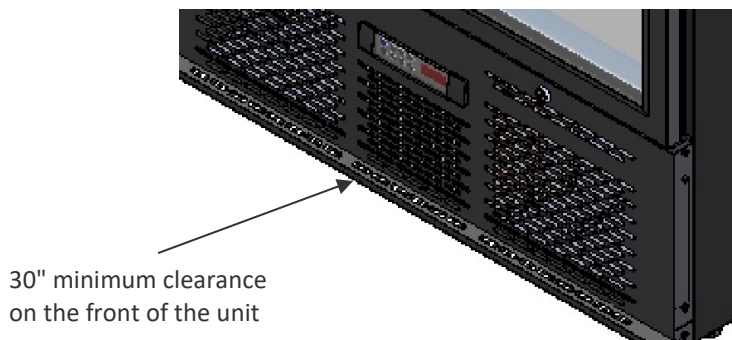



NOTE: Any restriction of the proper air flow, total or partial, will avoid the warranty on the unit.

5.4 Leveling

Its extremely important that the cabinet is perfectly level for proper operation so that the drain pan will drain properly, the doors will line up with the frames and the unit will not be subject to undue strain.

We install feet adjustable from factory. You can adjust these feet as you wish



5.5 Sealing Case to Floor

To maintain NSF Sanitation listing cases must sealed to the floor. Use NSF sealant such as silicone or equivalent cove mouldings or tiles are acceptable.

Do not block any louvered holes.



5.6 Initial cleaning procedure



Before starting-up and placing any food inside the cabinet, firstly remove the protective film and then clean the complete unit thoroughly. If any adhesive remains, eliminate it with alcohol. Washing with a mild soap and warm water solution is recommended for cleaning all the stainless-steel surfaces of your cabinet. This should be followed by cleaning with a baking soda solution. Rinse thoroughly with clear water and dry with a clean, soft cloth.



NOTE: Never use abrasive or harsh cleaners, concentrated detergents, solvents or chemicals when cleaning the unit.

6 ELECTRICAL INSTRUCTIONS

The supply voltage should be checked before connection to assure that proper voltage for the cabinet wiring is available. To determine correct unit voltage, please refer to the serial data plate located on an inner wall of the unit. Verify that this information exactly matches the electrical characteristics at the installation location.



NOTE: We requires that a sole use circuit be dedicated for the unit. Failure to do so voids warranty.

NOTE: The unit is designed to operate with a voltage fluctuation of 5% of the voltage indicated on the cabinet serial data plate. Burnout of the compressor due to exceeding the high or low voltage limits will automatically void the factory warranty.

Units are provided with a U.L. approved power cord and plug which is factory installed. Infrico use these types of plugs. If you do not have the right outlet have a certified electrician install the correct power source:



115 / 60 / 1 NEMA 5-15P

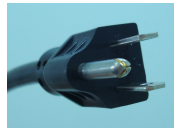

115 / 60 / 1 NEMA 5-20P



WARNING: Any alterations to this cord and plug could cause an electrical hazard and will void the factory warranty. Furthermore, never use an adapter plug.



WARNING: We will not warranty any units that are connected to an extension cord.

7 STARTUP PROCEDURE

After the cabinet has been installed, levelled, cleaned and electrically connected in accordance with this manual, it is ready to operate.

7.1 Digital temperature controller (Carel)

These units are equipped with a digital temperature controller located in the front panel.

This digital controller is fitted with a very powerful display, with 3 digits and decimal point and icons. The keypad ensures ease of use and reliability, and allows direct access to several operation functions.



ERV 25

KEYPAD

1. **HACCP**: Enter the HACCP alarm display menu (optional).
2. **AUX**: Deactivated in these models.
3. **LIGHT**: Deactivated in these models.
4. **UP / CC**: If pressed for more than 5 seconds, activates/deactivates continuous cycle operation.
5. **ON/OFF**: If pressed for more than 5 seconds, it will turn the equipment on/off.
6. **PRG/MUTE**: In the event of an alarm: this mutes the sound alarm (buzzer) and deactivates the alarm relay.
7. **DOWN / DEF**: If pressed for more than 5 seconds, it will turn manual defrosting on/off provided the evaporator temperature is lower than the final programmed defrosting temperature.
8. **SET**: If pressed for more than 1 second, it will display and/or confirm the set point.

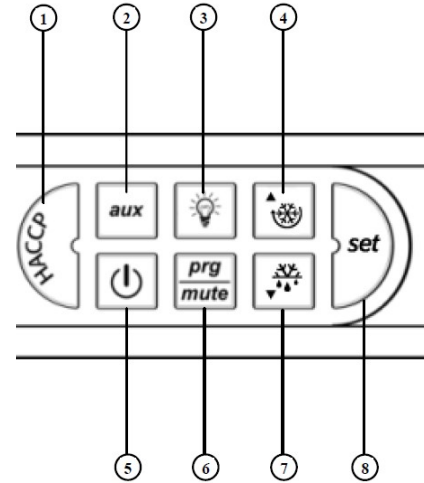

DISPLAY AND ICONS

Icon	Function	Normal Operation			Start-up
		ON	OFF	Flashing	
	COMPRESSOR	Compressor on	Compressor off	Compressor required	
	FAN	Fan on	Fan off	Fan required	
	DEFROST	Defrost in operation	Defrost not in operation	Defrost required	
AUX	AUX	AUXILIARY Auxiliary output active	AUXILIARY Auxiliary output not active		
	ALARM	Delayed external alarm (before "A7")	No alarm present	Alarms in normal operation	
	CLOCK	At least 1 timed defrost has been configured.	No timed defrost is present.		ON if real-time clock is present
	LIGHT	LIGHT auxiliary output on	LIGHT auxiliary output off		
	ASSISTANCE		No malfunction	Malfunction	
HACCP	HACCP	HACCP functions enabled	HACCP functions not enabled	HACCP alarm saved to memory	
	CONTINUOUS CYCLE	CONTINUOUS CYCLE function activated	CONTINUOUS CYCLE function deactivated	CONTINUOUS CYCLE function request	

7.2 Start-up

Plug the apparatus into an electrical socket.

The digital controller will display "OFF" and alternatively the cabinet temperature.



Connect the start-up ON/OFF button during more than 5 seconds. The cabinet temperature will be displayed and "OFF" will disappear. The compressor starts up after 1 minute.

The system should run smoothly and quietly in accordance with generally accepted commercial standards. If any unusual noises are heard, turn the unit off immediately and check for any obstructions of the fans.

All cabinets must be given enough time to reach normal operating temperature before placing any food inside cabinet or pans (if equipped). Continuous opening and closing of the doors / drawers will hamper the unit's ability to maintain optimum refrigeration performance.



NOTE: Before loading product, we recommend to run the unit empty during 24 hours. Refrigerated Back-Bar and Merchandiser are designed to maintain an approximate temperature of 39°F.

8 OPERATION



8.1 Temperature control adjustment

Setting the set point

The set point establishes the high point of the desired cabinet temperature range. This parameter is preset at the factory and does not have to be adjusted unless the customer chooses to do so.

To display or set the set point, proceed as follows:

1) Press  for more than 1 second to display the set point;

2) Increase or decrease the set point using the  and  buttons respectively, until reaching the desired value;

3) Press  again to confirm the new value.

Refrigerated Back-Bar (ERV) and Merchandiser (ERC)

The thermostat is factory set at 39°F. The minimum temperature that can be set for the set point is 28°F.

Re-establishing manual reset alarm

It is possible to re-establish all manual reset alarms by pressing the "PROG/MUTE" and "CONTINUOUS CYCLE" buttons at the same time for more than 5 seconds.

8.2 Defrost control

All these models are equipped with an automatic defrost system which clears the evaporator coil of any accumulated frost. Frost is accumulated on the evaporator coil during the normal operation. The defrost are time-initiated and temperature-terminated.

In refrigerators, prep tables and chef bases, defrost system works by switching-off the condensing unit and switching-on the evaporator fan(s). The defrost cycle occurs automatically every four hours and is indicated by the letters "dEF" displayed on the screen. The defrost cycle should last until the temperature set for the end of the defrost cycle is reached or for a maximum of 30 minutes.

Freezer models have a hot gas defrost system. Hot gas defrost system works by routing superheated compressor discharge gas directly to the evaporator. The defrost cycle occurs automatically every three hours and is indicated by the letters "dEF" displayed on the screen. The defrost cycle should last until the temperature set for the end of the defrost cycle is reached or for a maximum of 30 minutes.

At the end of the defrost cycle, the cabinet starts with normal refrigeration operation.







Starting a Manual Defrost Cycle

In case a manual defrost is required, it is possible to activate it by pressing  button for 5 seconds.

8.3 Adjusting operation parameters

There are some parameters that can be modified by the user. To access the frequent parameters, proceed as follows:

Press  for more than 5 seconds (if an alarm is active, the buzzer is muted), the display shows the code of the first modifiable parameter. Then, follow the next instruction:

- 1) Press  or  until reaching the parameter to be modified;
- 2) Press  to display the associated value;
- 3) Increase  or  decrease the value with the or buttons respectively, until reaching the desired value;
- 4) Press  to temporarily save the new value and return to the display of the parameter code;

Important: To definitively save the new values of the modified parameters, press exiting  for more than 5 seconds, thus the parameter setting procedure.

All the modifications made to the parameters, temporarily saved in the RAM, can be cancelled and "normal operation" resumed by not pressing any button for 60 seconds, thus allowing the parameter setting session to expire due to timeout.

Important: if the programming session ends by timeout, the parameters relating to the clock will not be reset, as these parameters are saved immediately when entered.

If the instrument is switched off before pressing saved  , all the modifications made to the parameters and temporarily will be lost.

Adjusting the Set Point Differential (rd)

This parameter sets the number of degrees the air temp will rise above set point before the refrigeration system will cycle on. In refrigerators and prep tables models, the set point differential is set at 7.2 which will allow the air temperature to rise 7.2 degrees above set point setting before cycling refrigeration on. In freezers, the set point differential is set at 5.4. This parameter is preset at the factory and does not have to be adjusted unless the customer chooses to do so.

To set the set point differential, the parameter that should be changed is "**rd**" according to the previous instructions. The range of adjustment that we recommend is 3.6°F / 10.8°F. Low values guarantee a room temperature that deviates only slightly from the set point, but involves frequent starts and stops of the compressor.

Adjusting the Thermostat Probe Calibration (/c1)

This parameter is used to correct the temperature measured by the probe, using an offset. The value assigned to this parameter is in fact added to (positive value) or subtracted from (negative value) the temperature measured by the probe. The temperature value is corrected by the offset before checking if the reading is out-of range.

To set the thermostat probe calibration, the parameter that should be changed is "**/c1**". The default value is 0 which means that there is no offset to the reading of probe 1.

Adjusting the Anti-Short Cycle Delay (c1)

This parameter sets the minimum time (in minutes) between two starts of the compressor, irrespective of the temperature and the set point. Setting this parameter limits the number of starts per hour. To set the anti-short cycle delay, the parameter that should be changed is "**c1**". The default value is 1minute.

Adjusting the Interval between Defrost Cycles (dl)

The defrost cycles are performed periodically at an interval equal to the value of "dl" in hours. The interval "dl" starts being counted from the end of the previous count. The duration of the defrost therefore does not affect then the interval between defrost cycles. The interval "dl" is cyclical and is also maintained when the controller is OFF. If the interval "dl" expires when the controller is OFF, when it is started again a defrost will be performed.

If "dl"=0 the defrost is never performed except for when forced from the keypad (manual defrost).

Important: To ensure regular defrosts, the interval between defrost cycles must be greater than the maximum defrost duration, plus the dripping time and post-dripping time.

Note: during defrost cycles the temperature alarms are disabled.

The parameter is "dl". The default value is 4 hours in refrigerated tables, prep tables and chef bases. In freezer, the default value is 3 hours.

Adjusting the Maximum Defrost Duration (dP1)

This parameter determines the maximum defrost duration on the evaporator in minutes if defrost by temperature is selected. If timed defrost has been selected, this represents the actual duration of the defrost selected. The parameter is "dP1" . The default value is 30 minutes.

Summary of parameters that can be modified by the user

SUMMARY OF USER / SERVICE PARAMETERS		Default settings for:			
		Back-Bar		Merchandiser	
LABEL	NAME	RANGE	DEFAULT VALUE	RANGE	DEFAULT VALUE
St	Set Point	-32°F/60,8 °F	36	-32°F/60,8 °F	36
rd	Differential	0,2 °F/36 °F	7,2	0,2 °F/36 °F	7,2
/cl	Thermostat Probe Calibration	-36 °F/36 °F	0	-36 °F/36 °F	0
cl	Anti-Short Cycle Delay	0/15 min.	1	0/15 min.	1
dl	Interval Between Defrost Cycles	0 h./250 h.	4	0 h./250 h.	4
dP1	Maximum Length of Defrost	1 min./250 min.	30	1 min./250 min.	30

8.4 Digital temperature controller (Dixell)



These units are equipped with a digital temperature controller located in the front panel.

This digital controller is fitted with a very powerful display, with 3 digits and decimal point and icons. The keypad ensures ease of use and reliability, and allows direct access to several operation functions.

The temperature is set at the factory but local conditions may need slight adjustment.

: This turns the condensing unit and lights off. There is still power to the controller.

SET: for displaying or modifying the set point. When displaying the maximum and minimum temperature, these can be deleted by keeping the button pressed for 3 second.

 (UP): This displays the maximum stored temperature; in programming mode and "Function Menu" mode it is used to look through the parameter codes or increase the value of the variable in use.

 (DOWN) This displays the minimum stored temperature; in programming mode and "Function Menu" mode it is used to look through the parameter codes or decrease the value of the variable in use.

: This turns the light on and off.

Note: while in the OFF status, the light button is active

8.5 Loading product

- Before introducing food into the cabinet, it is advisable to leave it empty while in operation until it reaches the working temperature. Once this has been reached, you can proceed to load the equipment.
- When introducing food, enough space must be left between the goods to enable air circulation.
- Never allow the goods to prevent doors from closing.
- Do not exceed the maximum weight per shelf of 55 lb.
- Do not obstruct the fan with the load and assure that this never exceeds the maximum load level determined. The load must therefore always be situated underneath the fan.
- Never put hot food in the cabinet.
- Do not leave food inside the unit when it is going to remain shut down either from a power outage or fault in the equipment.
- If the cabinet is going to remain shut down for prolonged periods, try to leave it unplugged, empty, clean and with door ajar.
- Food or drinks may be well wrapped or enclosed in airtight containers to avoid odours inside the unit.

9 ACCESSORIES

9.1 Shelving

Installation of shelves

Back-Bar are supplied from factory with pilasters, stainless steel rails and stainless steel shelves. Shelf rails are installed by inserting them into the pilasters at the desired shelf location. Then, place shelves on the rails, making sure they are seated properly.

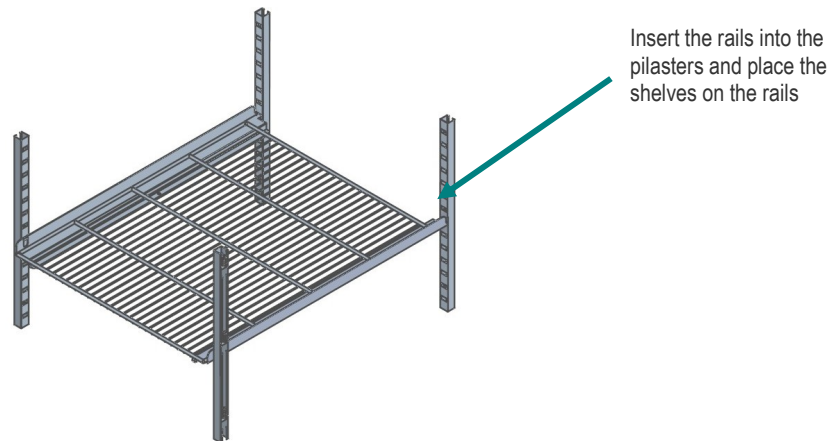

10 MAINTENANCE, CARE AND CLEANING

10.1 Cleaning procedure

Cleaning the cabinet

To clean the cabinet, the following instruction should be followed:

- Disconnect the unit from the power supply and remove all food product from inside.
- Open all doors and allow the cabinet to reach room temperature. Remove all accessories and clean them with a baking soda or mild soap and warm water solution. Dry all of the accessories completely with a soft clean cloth.
- Once the cabinet has reach room temperature, wash the entire cabinet inside and out with a baking soda or mild soap and warm water solution. Rinse thoroughly with clear water and dry with a soft clean cloth. Failure to dry all surface completely may cause water stains. There are also stainless steel cleaners available which can restore and preserve the finish of the steels protective layer.
- Return all accessories to their initial positions and plug the unit in.
- Early signs of stainless steel breakdown can consist of small pits and cracks. If this has begun, star to apply stainless steel cleaners in order to restore the passivity of the steel.
- Many product foods have an acidic content which can attack stainless steel, such as mustard, mayonnaise, lemon juice, tomatoes and other vegetables.



NOTE: Never use steel pads, wire brushes or scrapers to clean the cabinet.



NOTE: Cleaning solutions need to be alkaline based or non-chloride cleaners. Any cleaner containing chlorides will damage the protective film of the stainless steel.

Gaskets Maintenance

- Gaskets require regular cleaning to keep their elasticity, to maintain proper sealing and to prevent mildew build up. Gasket cleaning can be done with the use of warm soapy water. Avoid hard cleaners and sharp tools when cleaning gaskets.
- Gaskets can easily be replaced just pulling out of the grove in the door and new gaskets can be pressed back into place.



Cleaning the condenser coil

The condenser coil, which is located directly behind the front panel, must be checked periodically. The frequency of cleaning depends on the operating environment. Air must be able to freely circulate through the condenser, so the surface of the condenser must be kept free of dirt and grease for proper system operation. Dirty condensers result in compressor failure and product loss. If the condenser coil is dirty or blocked, follow this instruction:

- Disconnect the power supply
- Remove the screws on the hinged front panel of the cabinet and open it.
- Slide out the condensing unit, and the condenser is easy accessible.
- Carefully clean dirt from the condenser using a vacuum cleaner or soft brush; never use a wire brush.
- Heavier dust build up may require compressed air to blow through the condenser coil.
- Slide the condensing unit back into position.
- Finally, replace the front panel, tighten all screws and reconnect electrical power supply.



WARNING: Never use water for this cleaning procedure as water can damage the electrical components located near or at the condenser coil.

Doors/Hinges Maintenance

Over time and with heavy use doors the hinges may become loose. If it is noticed that the door is beginning to sag, it may become necessary to tighten the screws that mount the hinge brackets to the frame of the unit.

Drain Maintenance

Each unit has a drain located inside the unit which removes the condensation from the evaporator coil and evaporates it at an external condensate pan. If you notice excessive water accumulation on the inside of the unit be sure the drain tube is connected from the evaporator housing to the condensate evaporator drain pan.

If water is collected underneath the unit you may want to check the condensate evaporator drain tube to be sure it is still located inside the drain pan.

Be sure all drain lines are free of obstructions, typically food product is found blocking drain lines causing water to back up and overflow the drain pans.

10.2 Parts and Service



WARNING: Make sure that the equipment is unplugged before cleaning or repairing it.

If the problem persists after you have carried out the indicated checks, "DO NOT MAKE ANY REPAIRS YOURSELF". Contact our Technical Service. Always provide the cabinet model and serial number (located on the data plate, 15 digits)

NOTE: When a replacement part is required, always insist on factory authorized parts only.

11 TROUBLE SHOOTING CHART

Many operating problems are derived from causes that can be easily eliminated without the need to contact the Technical Department. The following page shows a table with types of problems that may come up, their cause, and how to resolve them.

PROBLEM	POSSIBLE SOLUTION
Compressor will not start-no hum.	1.- Disconnect switch open. 2.- Blown fuse. 3.- Defective wiring. 4.- Overload protector tripped. 5.- Open control contacts (control may be defective, or unit location may be too cold). 6.- Defective overload protector. 7.- Low charge of freon-check for leaks.
PROBLEM	POSSIBLE SOLUTION
Compressor will not start-no hums but cycles on overload.	1.- Low voltage. 2.- Unit wired incorrectly. 3.- Starting capacitor defective. 4.- Starting capacitor seal. 5.- Compressor motor defective. 6.- High head pressure. 7.- Bearing of pistons tight-low oil charge.
Compressors start, but starting remains in circuit.	1.- Low voltage. 2.- Unit wired incorrectly. 3.- Starting capacitor seal. 4.- Running capacitor defective. 5.- Starting relay defective. 6.- High head pressure. 7.- Bearings of pistons tight-low oil charge.
Compressor starts and runs, but cycles on overload	1.- Low voltage. 2.- Running capacitor defective. 3.- Overload protector defective. 4.- High head pressure. 5.- Fan motor, pump, etc... , wire to wrong of overload protector.
Compressor tries to start when thermostat closes but cuts out on overload, start after several attempts.	1.- Low voltage. 2.- Start capacitor defective. 3.- Overload protector defective. 4.- High head pressure. 5.- Fan motor, pump, etc... , wire to wrong of overload protector.

Compressor tries to start when thermostat closes but cuts out on overload, start after several attempts.	<ol style="list-style-type: none"> 1.- Low voltage. 2.- Low on oil. 3.- High head pressure. 4.- Starting relay points badly pitted. 5.- Starting capacitor weak. 6.- Air or non-condensable gases in system.
Compressor starts but immediately cuts out on overload	<ol style="list-style-type: none"> 1.- Starting relay contacts points welded together. 2.- Starting capacitor defective. 3.- Compressor short cycles.
Starting relay burns out.	<ol style="list-style-type: none"> 1.- Low voltage. 2.- High voltage. 3.- Compressors short cycles. 4.- Incorrect running capacitor. 5.- Incorrect relay.
PROBLEM	POSSIBLE SOLUTION
Running capacitors burn out.	<ol style="list-style-type: none"> 1.- Line voltage too high.
Head pressure to high	<ol style="list-style-type: none"> 1.- Unit overcharged. 2.- Air or other non-condensable gases in system. 3.- Clogged condenser (air-cooled) 4.- Defective condenser fan motor. 5.- Unit location too hot. 6.- Restriction in expansion valve, strainer or drier. 7.- Discharge valve partially closed. 8.- Restriction in discharge line.
Head pressure to low	<ol style="list-style-type: none"> 1.- Insufficient refrigerant charge. 2.- Leak in the system. 3.- Cold location.
Compressor short cycles	<ol style="list-style-type: none"> 1.- Control differential set too close. 2.- Refrigerant undercharge, check pressure control. 3.- Refrigerant overcharge. 4.- Discharge valve leaking. 5.- Cutting out on high pressure control, if used. 6.- Cutting out on overload protector because if tight bearings struck piston, high head pressure or restricted air cooled condenser.
Running cycles too long, or unit operates continuously	<ol style="list-style-type: none"> 1.- Insufficient refrigerant charge. 2.- Dirty or restricted condenser. 3.- Unit location too hot. 4.- Control contacts stuck. 5.- Air or other non-condensable gases in system.

	<p>6.- Expansion valve plugged or defective.</p> <p>7.- Fixture doors left open too long.</p> <p>8.- Insufficient, defective or water logged insulation.</p> <p>9.- Evaporated oil logged.</p>
<p>Noisy unit</p>	<p>1.- Compressor oil charge low.</p> <p>2.- Fan cable on condenser or evaporator bent causing vibrations.</p> <p>3.- Bearing on evaporator or condenser motors lose or worn.</p> <p>4.- Tube rattles.</p> <p>5.- Lose parts on condensing unit.</p> <p>6.- Case is not level.</p>