

Esplso Forno Best For 1065 Exploded View Best For 1065

Particolare
Single Item

Kit

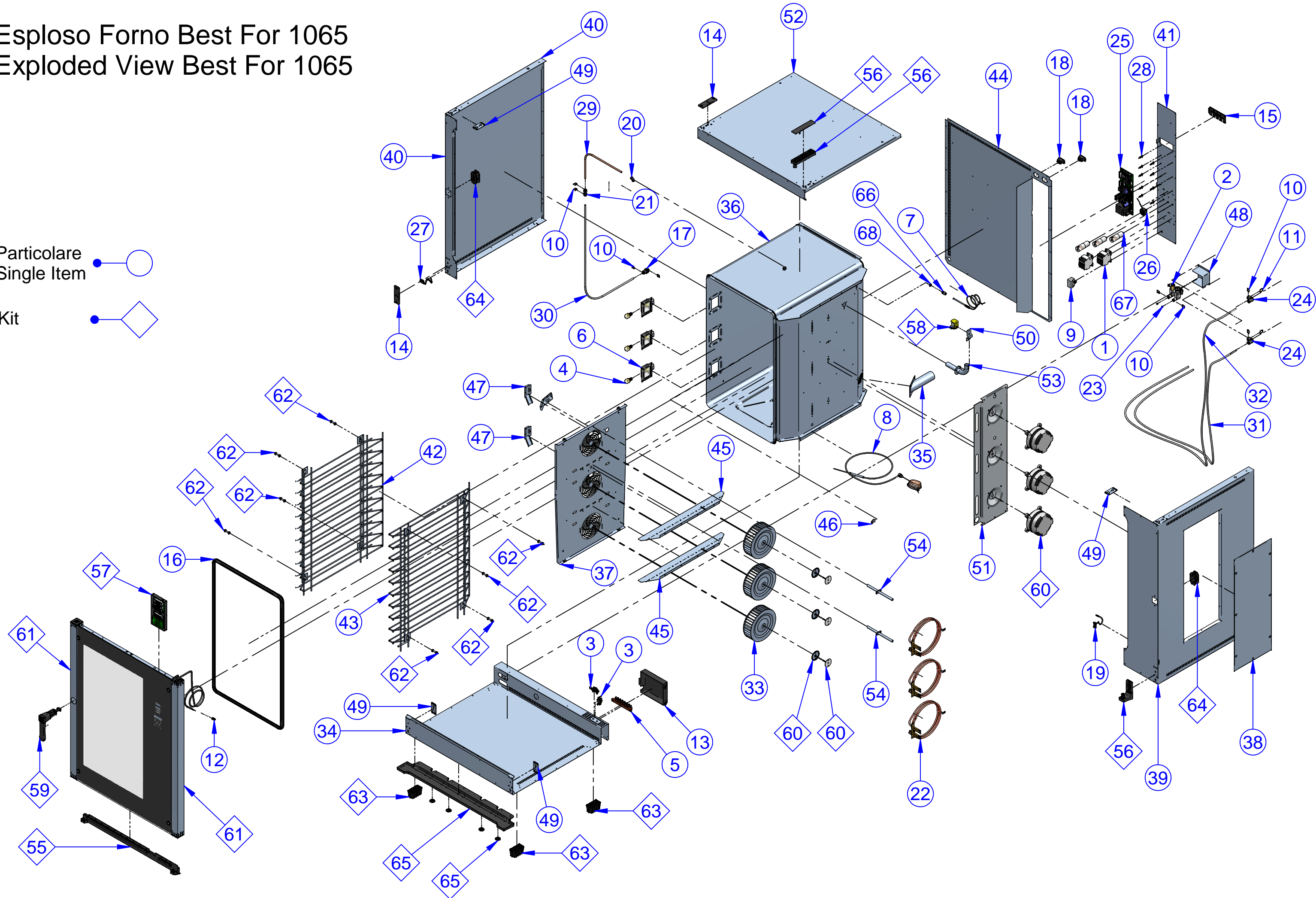

Particolare Impianto Idrico 1065 Water System 1065

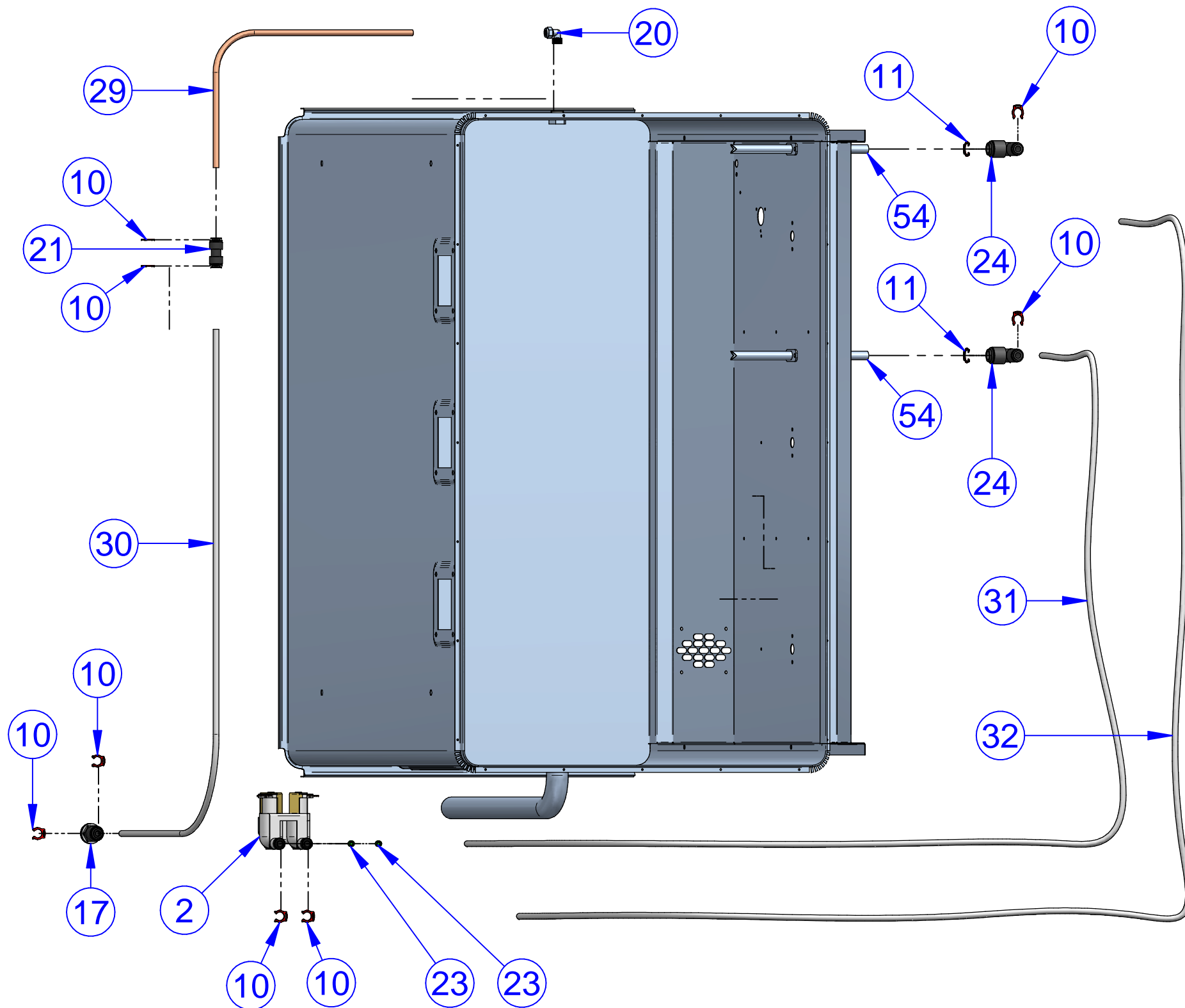
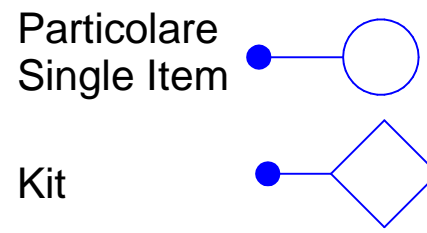

Componenti Pannello Elettrico e Centralina 1065 Back Power Panel and Front Control Panel 1065

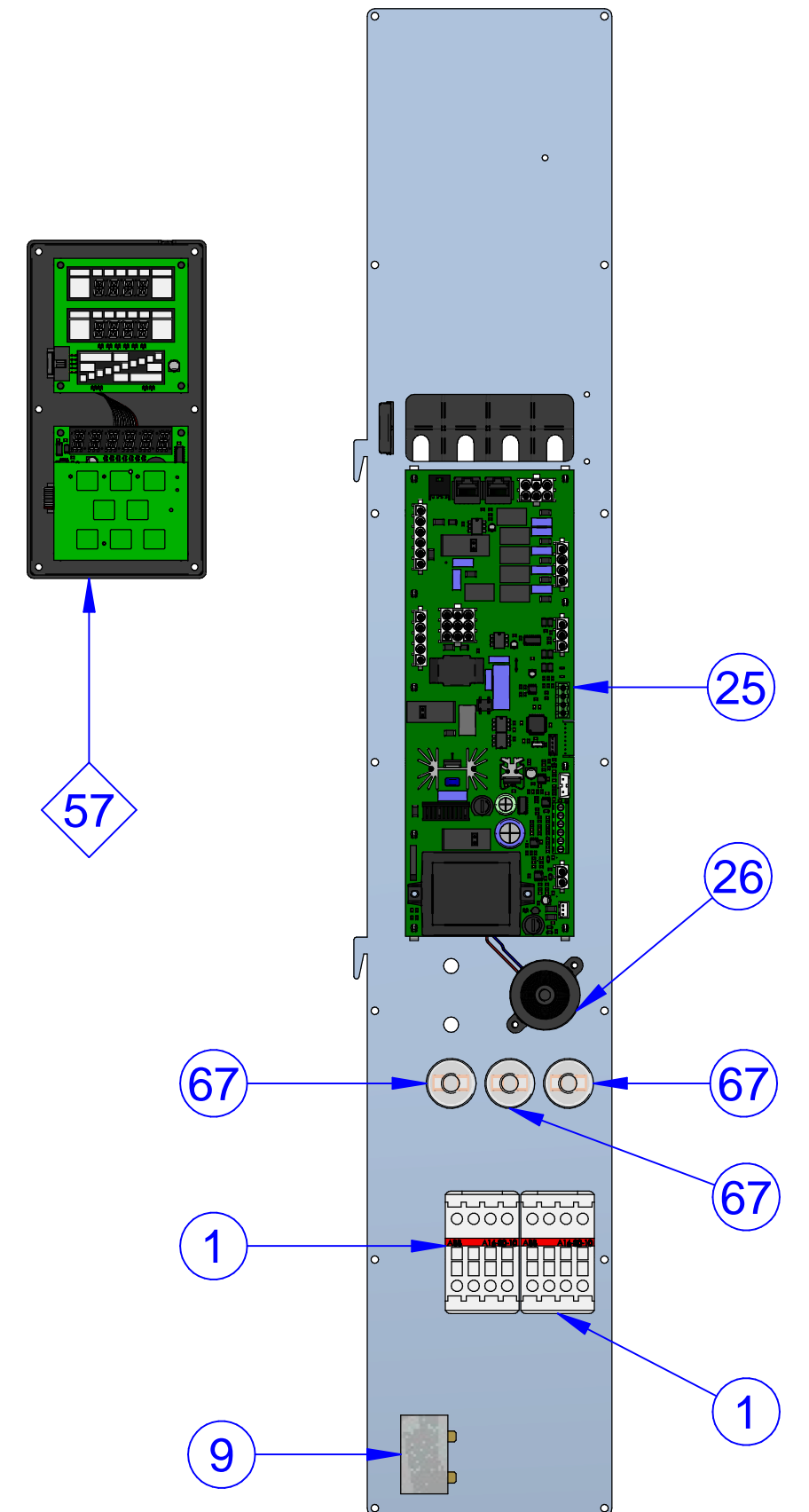

Esploso Kit Porta Completa 1065

Door Kit Best For 1065 Exploded View

Particolare
Single Item

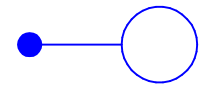

Kit



Tabella Componenti Forno 1065

N	Codice	Titolo	Description	Descripción	Description	Beschreibung	Q
1	113007020	Teleruttore ABB A16-30-10	Remote control switch ABB A16-30-10	Telerruptor ABB A16-30-10	Télerrupteur ABB A16-30-10	Fernschalter ABB A16-30-10	2
2	120800012	Elettrovalvola 230V 2 uscite JG	Solenoid valve 230V 2 JG outlets	Electroválvula 230V 2 salidas JG	Électrovanne 230V 2 sorties JG	Magnetventil 230V 2 Ausgänge JG	1
3	123507020	Fascetta BloccaCavo PA268	Cable clamp PA268	Banda bloqueo cable PA268	Collier bloque-câble PA268	Kabelklemme PA268	2
4	146600013	Lampadina 23 W 240 V 300°	23W 240V 300° la mp	Bombilla 23W 240V 300°	Lampe 23W 240V 300°	Leuchte 23W 240V 300°	3
5	153007020	Morsetto Terminale FV273 7 Poli	7-pole terminal clamp FV273 7	Borne terminal FV273 7 Polos	Borne terminal FV273 7 pôles	Klemme Terminal FV273 7-polig	1
6	166400010	Lampada Bistrot Completa	Complete Bistrot lamp	Bombilla Bistrot completa	Lampe Bistrot complète	Komplette Leuchte Bistrot	3
7	179600000	Sonda Jota Giunto Isolato 6x100 Cavo 1,5m	Insulated Jota joint probe 6x100 Cable 1.5m	Sonda Jota junta aislada 6x100 cable 1,5m	Sonde Jota joint isolé 6x100 Câble 1,5m	Fühler Jota isolierte Verbindung 6x100 Kabel 1,5m	1
8	179607520	Sonda Al Cuore SP G B 10 4 KKG 30.8 N N	Core probe SP G B 10 4 KKG 30.8 N N	Sonda aguja SP G B 10 4 KKG 30.8 N N	Sonde à cœur SP G B 10 4 KKG 30.8 N N	Kernfühler SP G B 10 4 KKG 30.8 N N	1
9	182500029	Termostato di Sicurezza 16A 250V t335°CT150	Safety thermostat 16A 250V t335°CT150	Termostato de seguridad 16A 250V t335°CT150	Thermostat de sécurité 16A 250V t335°CT150	Sicherheitsthermostat 16A 250V t335°CT150	1
10	312000020	Clip Blocca Pinzetta 8 JG PMC1808R	8 JG Pliers Locking Clip PMC1808R	Clip bloqueo pinza 8 JG PMC1808R	Clip 8 JG PMC1808R	Klammer Pinzettenbefestigung 8 JG PMC1808R	8
11	312000021	Clip Blocca Pinzetta 12 JG PIC1816R	12 JG Pliers Locking Clip PIC1816R	Clip bloqueo pinza 12 JG PIC1816R	Clip 12 JG PIC1816R	Klammer Pinzettenbefestigung 12 JG PIC1816R	2
12	313007020	Connettore Per Cavo D-P CNC PF04D1FF00	Connector for cable D-P CNC PF04D1FF00	Conector para cable D-P CNC PF04D1FF00	Connecteur pour câble D-P CNC PF04D1FF00	Steckverbinder für Kabel D-P CNC PF04D1FF00	1
13	313207020	Coperchio Morsettiera	Terminal board cover	Tapa bornera	Couvercle bornier	Abdeckung Klemmenleiste	1
14	313207025	Coperchio Fori Cerniera	Hinge slot cover	Tapa orificios bisagra	Couvercle orifices charnière	Abdeckung Scharnierbohrungen	2
15	313207030	Coperchio Prese Aux Centralina	Control unit aux socket cover	Tapa tomas aux centralita	Couvercle prises aux. de la centrale	Abdeckung zusätzl. Steckdosen Steuereinheit	1
16	331807020	Guarnizione Camera	Chamber gasket	Junta cámara	Joint chambre	Abdichtung Garraum	1
17	363600000	Passaparete Intermedio JG 8mm PM1208E	Intermediate coupling JG 8mm PM1208E	Pasa-pared intermedio JG 8mm PM1208E	Passe-mur intermédiaire JG 8mm PM1208E	Mittlerer Wanddurchlass JG 8mm PM1208E	1
18	366900008	Preso Pannello 43R031121	Panel fitting 43R031121	Toma Panel 43R031121	Prise panneau 43R031121	Steckdose Panel 43R031121	2
19	366907020	Prolunga Connettore Seriale PH003_A01	USB logger interface	Interfaz USB Logger	Interface USB logger	USB-Schnittstelle Logger	1
20	373000002	Raccordo a L D.8 1-4	L-shaped fitting D.8 1-4	Rácor en L D.8 1-4	Raccord en L D.8 1-4	L-förmiger Anschluss D.8 1-4	1
21	373000021	Raccordo intermedio Dritto 8-8 JG PM0408E	Straight intermediate fitting 8-8 JG PM0408E	Rácor intermedio recto 8-8 JG PM0408E	Raccord intermédiaire droit 8-8 JG PM0408E	Gerader Zwischenanschluss 8-8 JG PM0408E	1
22	373500040	Resistenza Bistrot 1064 230V 5000W	Bistrot 1064 heating element 230V 5000W	Resistencia Bistrot 1064 230V 5000W	Résistance Bistrot 1064 230V 5000W	Heizwiderstand Bistrot 1064 230V 5000W	3

Tabella Componenti Forno 1065

N	Codice	Titolo	Description	Descripción	Description	Beschreibung	Q
23	374000008	Riduttore Di Portata Verde 0,25 L-min	Flow reducer green 0,25 lt-min	Reductor de flujo verde 0,25 lt-min	flux réducteur vert 0,25 lt-min	Grüner Zuflussuntersetzer 0,25 lt-min	2
24	374000020	Riduzione a Gomito JG 12/8 PM211208E	Elbow adaptor JG 12/8 PM211208E	Codo reductor JG 12/8 PM211208E	Raccord coudé de réduction JG 12/8 PM211208E	Bogenreduzierung JG 12/8 PM211208E	2
25	378607020	Scheda Di Potenza PJ082_A01	Power board PJ082_A01	Tarjeta de potencia PJ082_A01	Carte de puissance PJ082_A01	Leistungskarte PJ082_A01	1
26	379200000	Segnalatore acustico nero	Black acoustic indicator	Avisador acústico negro	Avertisseur sonore noir	Summer schwarz	1
27	379206500	Sensore MK21-1A71C1000W	Sensor MK21-1A71C1000W	Sensor MK21-1A71C1000W	Capteur MK21-1A71C1000W	Fühler MK21-1A71C1000W	1
28	381000003	Supporto Plastica MPDSDST2SIY00 8mm	Plastic support MPDSDST2SIY00 8mm	Soporte plástico MPDSDST2SIY00 8mm	Support en plastique MPDSDST2SIY00 8mm	Kunststoffhalterung MPDSDST2SIY00 8mm	9
29	385500002	Tube in rame D. 8	Copper pipe D. 8	Tube en cobre 8	Tuyau en cuivre D. 8	Kupferrohr D. 8	1
30	385500020	Tube Pe Trasparente JG 8x6 PE-006-100M-N	Transparent PE Pipe JG 8x6 PE-006-100M-N	Tube Pe transparente JG 8x6 PE-006-100M-N	Tube Pe transparent JG 8x6 PE-006-100M-N	Transparenter PE-Schlauch JG 8x6 PE-006-100M-N	1
31	385500020	Tube Pe Trasparente JG 8x6 PE-006-100M-N	Transparent PE Pipe JG 8x6 PE-006-100M-N	Tube Pe transparente JG 8x6 PE-006-100M-N	Tube Pe transparent JG 8x6 PE-006-100M-N	Transparenter PE-Schlauch JG 8x6 PE-006-100M-N	1
32	385500020	Tube Pe Trasparente JG 8x6 PE-006-100M-N	Transparent PE Pipe JG 8x6 PE-006-100M-N	Tube Pe transparente JG 8x6 PE-006-100M-N	Tube Pe transparent JG 8x6 PE-006-100M-N	Transparenter PE-Schlauch JG 8x6 PE-006-100M-N	1
33	391500016	Ventola Pale Dritte VE14582 Diametro 200x61	Straight blade fan VE14582 Diameter 200x61	Ventilador palas rectas VE14582 Diámetro 200x61	Vanne à pales droites VE14582 Diamètre 200x61	Geblase gerade Schaufeln VE14582 Durchmesser 200x61	3
34	505607020	Basamento	Base	Base	Base	Unterteil	1
35	510607021	Camino Posteriore	Rear flue	Chimenea trasera	Cheminée postérieure	Rückseitiger Kamin	1
36	510613020	Camera Di Cottura	Cooking chamber	Cámara de cocción	Chambre de cuisson	Garraum	1
37	513113020	Convogliatore Aria Grigliato	Grilled air conveyor	Direccionador aire con rejilla	Convoyeur d'air à grille	Luftführung mit Gitter	1
38	513213020	Coperchio Motori	Motor cover	Tapa motores	Couvercle moteurs	Motorenabdeckung	1
39	546613020	Laterale Destro	Right side	Lateral derecho	Latéral droit	Rechte Seite	1
40	546613030	Laterale Sinistro	Left side	Lateral izquierdo	Latéral gauche	Linke Seite	1
41	563713020	Pannello Impianto Elettrico	Electrical system panel	Panel instalación eléctrica	Panneau installation électrique	Anlagentafel	1
42	566513020	Portateglie Sinistro	Left pan support	Portabandejas izquierdo	Porte-plats gauche	Linker Blechhalter	1
43	566513030	Portateglie Destro	Right pan support	Portabandejas derecho	Porte-plats droit	Rechter Blechhalter	1
44	573613020	Retro Forno	Oven Back	Trasera horno	Arrière four	Ofenrückseite	1
45	579207020	Separatore Ventole	Fan separator	Separador ventiladores	Séparateur vannes	Luftabscheider	2
46	580306021	Squadretta Spruzzatori	Spray nozzle bracket	Escuadra rociadores	Équerre vaporisateurs	Winkelplatte Sprühdüsen	1
47	580306500	Squadretta spruzzatore	Spray nozzle bracket	Escuadra rociador	Équerre vaporisateur	Winkelplatte Sprühdüse	3
48	581007020	Supporto Elettrovalvola	Solenoid valve support	Soporte electroválvula	Support électrovanne	Magnetventilträger	1

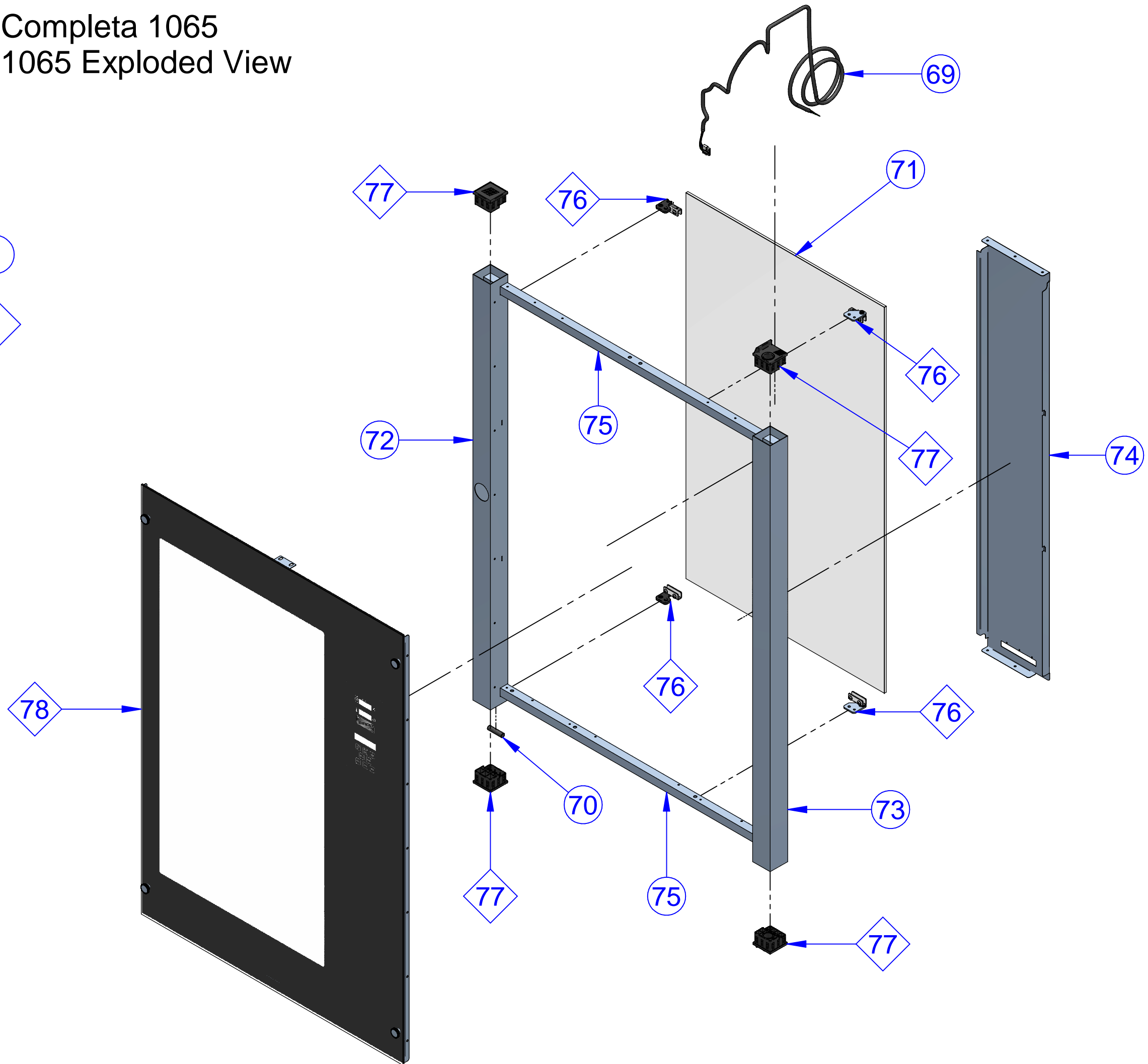
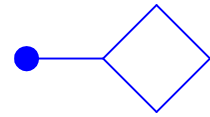
Tabella Componenti Forno 1065

N	Codice	Titolo	Description	Descripcìon	Descriptiòn	Beschreibung	Q
49	581007030	Supporto\Rinforzo Cerniera	Hinge support/reinforcement	Soporte/refuerzo bisagra	Support\Renforcement de la charnière	Scharnierhalterung\Verstärkung	4
50	581107021	Supporto Attuatore Aria	Air actuator support	Soporte actuador aire	Support actionneur d'air	Halterung Luftantrieb	1
51	581113020	Supporto Motori	Motor support	Soporte motores	Support moteurs	Motoren halterung	1
52	582607020	Tetto	Top panel	Techo	Toit	Abdeckung	1
53	585507040	Tubo Ingresso Aria Corto	Air inlet pipe	Tubo entrada aire	Tuyau d'entrée de l'air	Lufteintrittsrohr	1
54	585507050	Tubo Ingresso Acqua Corto	Water inlet pipe	Tubo entrada agua	Tuyau d'entrée de l'eau	Wassereinlaufrohr	2
55	70607030	Kit Vaschetta Vetro (465-665-1065)	Glass tray (465 665 1065) Kit	Kit Bandeja vidrio (465 665 1065)	Kit Bac vitre (465 665 1065)	Kit Glasauffangwanne (465 665 1065)	1
56	711007030	Kit Cerniere Porta Serie Star	Door hinge Serie Star Kit	Kit Bisagra puerta Serie Star	Kit charnière porte Serie Star	Türscharnier Kit Serie Star	1
57	715707020	Kit Centralina Frontale Serie Star Verticale	Front Control unit Serie Star Kit (vertical)	Kit Frontal centralita Serie Star (vertical)	Kit Frontal centrale Serie Star (verticaux)	Vorderseitiges Steuerneinheit-Kit Serie Star (senkrecht)	1
58	734600003	Kit Attuatore	Actuator Kit	Kit Actuador	Kit Actionneur	Kit Antrieb	1
59	751607900	Kit Maniglia Serie Star	Handle Serie Star Kit	Kit Tirador Serie Star	Kit Poignée Serie Star	Griff Kit Serie Star	1
60	753000030	Kit Motore K48210 Serie Star	Motor Kit K48210 Serie Star	Kit Motor K48210 Serie Star	Kit Moteur K48210 Serie Star	Motor Kit K48210 Serie Star	3
61	753113030	Kit Porta Completa 1065 Serie Star	Complete door 1065 Serie Star Kit	Kit Puerta completa 1065 Serie Star	Kit Porte complète 1065 Serie Star	Komplettes Tür Kit 1065 Serie Star	1
62	764107020	Kit Perni Supporto 2 Posizioni Guida Teglie Bistrot	Pan guide support pin - 2 positions Bistrot Kit	Kit Perno sop. guía bandejas 2 posiciones Bistrot	Kit Axe supp. glissière plats à four 2 positions Bistrot	Kit Zapfen Blechführungshalter 2 Stellungen Bistrot	1
63	764507020	Kit 4 Piedini di Supporto Forno	Oven 4 feet kit	Kit 4 Patas soporte	Kit 4Pieds de support	Kit 2 Ofenstützfüße	1
64	779207030	Kit Serrature in Plastica	Plastic lock Kit	Kit Cerradura de plástico	Kit Serrure en plastique	Schlösserkit aus Kunststoff	1
65	790607020	Kit Vaschetta Sottoporta(446-465-665-1065-1021)	Under-door tray Kit (446-465-665-1065-1021)	Kit Bandeja bajo puerta (446-465-665-1065-1021)	Kit Bac sous-porte (446-465-665-1065-1021)	Kit Auffangwanne unter der Tür (446-465-665-1065-1021)	1
66	Commerciale	Raccordo Porta Sonda Jota	Jota probe holder fitting	Rácor portasonda Jota	Raccordo porte sonde Jota	Anschluss Türfühler Jota	1
67	Commerciale	Condensatore 5mF Ducati Energia	Condenser 5mF Ducati Energia	Condensador 5mF Ducati Energia	Condensateur 5mF Ducati Énergie	Kondensator 5mF Ducati Energia	3
68	Commerciale	Dado 1/8 Gas Inox	Nut 1/8 gas inox	Tuerca 1/8 gas inox	Écrou 1/8 gaz inox	Mutter 1/8 gas inox	1

Tabella Componenti Kit Porta Completa 1065

N	Codice	Titolo	Description	Descripcìon	Descriptiòn	Beschreibung	Q
69	310507020	Cavo Collegamento Display-Potenza CB04V4000MKZZ	Display-Power connection cable CB04V4000MKZZ	Cable conexión pantalla-potencia CB04V4000MKZZ	Câble de branchement écran-Puissance CB04V4000MKZZ	Anschlusskabel Display-Leistung CB04V4000MKZZ	1
70	351600008	Magnete Micro Porta	Door micro magnet	Imán microinterruptor puerta	Aimant micro porte	Türmikromagnet	1
71	391613030	Vetro Interno	Internal glass	Vidrio interno	Vitre interne	Innenglas	1
72	553113025	Montante Porta Lato Maniglia Plastica	Door upright on plastic handle side	Montante puerta lado tirador plástico	Montant porte côté poignée en plastique	Türholm Kunststoffgriffseite	1
73	553113030	Montante Porta Lato Cerniere	Door upright on hinge side	Montante puerta lado bisagras	Montant porte côté charnière	Türholm scharnierseitig	1
74	578713020	Schermo Protezione Centralina	Control unit protection screen	Pantalla protección centralita	Écran de protection de la centrale	Schutzabdeckung Steuereinheit	1
75	584507020	Traversa Porta	Door cross-piece	Travesaño puerta	Barre porte	Querstrebe der Tür	2
76	712007020	Kit Montaggio Vetro Interno Serie Star	Assembly inner Glass Serie Star Kit	Kit Montaje vidrio interno Serie Star	Kit Assemblée vitre interne Serie Star	Montage Kit inner Glases Serie Star	1
77	782007020	Kit Tappi Porta Serie Star	Door plugs Serie Star Kit	Kit Tapón puerta Serie Star	Kit Cache porte Serie Star	Türabdeckkappe Kit Serie Star	1
78	791613020	Kit Vetro Esterno Bistrot 1065	Outer glass Bistrot 1065 Kit	Kit Vidrio externo Bistrot 1065	Kit Vitre externe Bistrot 1065	Kit Außenglas Bistrot 1065	1