

Oven body

#	Code	Description	Specification	UM	Qty
65	040GUA00002	DOOR GASKET COMBISTEAMER		cm	440
69	60NASAI001	HANDLE STUD L70MM		pz	1
70	60PERAI003	HANDLE PIVOT RCB-RCG		pz	1
91	50PIEAI005	FOOT FOR 16-20 TRAYS OVENS		pz	4
98	020MOR0001	GROUND TERMINAL		pz	1
115	10SCNZ10NSU050	OVEN BACKSIDE		pz	1
118	85CER00013	LOWER DOOR SUPPORT FOR OVEN		pz	1
119	85CER00014	LOWE DOOR SUPPORT FOR OVEN		pz	1
120	10PIAA20NAA044	PLATE		pz	1
121	10PIAA10SAA013	PLATE		pz	1
171	10SCNZ10NIN051	OVEN BACKSIDE		pz	1
174	20SNS00006	DOOR MAGNETIC SENSOR		pz	2

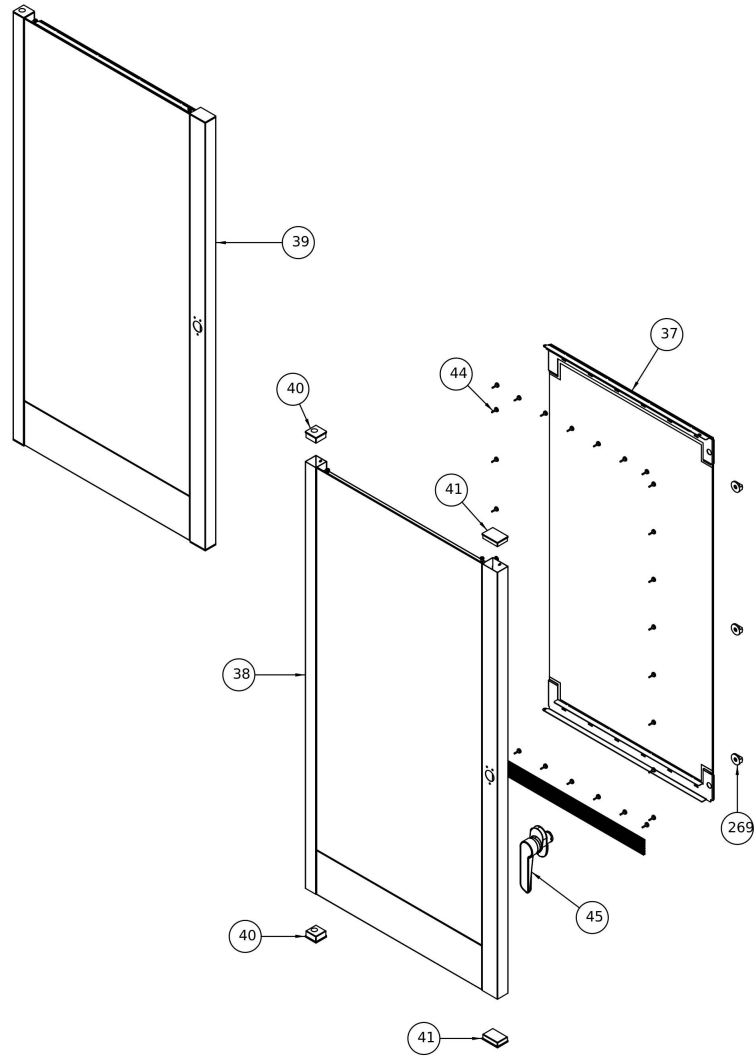

Door

#	Code	Description	Specification	UM	Qty
37	AVI20T	COMPLETE INTERNAL GLASS DOOR		pz	1
38	TBC-85AVE00047*	COMPLETE EXTERNAL GLASS FOR SQUERO 16-20	To order share oven s/n	pz	1
39	TBC-85PTA00093*	COMPLETE DOOR FOR FOR SQUERO 16-20	To order share oven s/n	pz	1
40	040TAP00018	PLASTIC COVER OVEN DOOR		pz	2
41	040TAP00002	PLASTIC COVER OVEN DOOR		pz	2
44	040TAP00015	INTERNAL GLASS HINGE		pz	38
45	TBC-85MNG00001*	DOOR HANDLE	To order share oven s/n	pz	1
269	040MAN00010	INTERNAL GLASS BLOCKING KNOB		pz	3

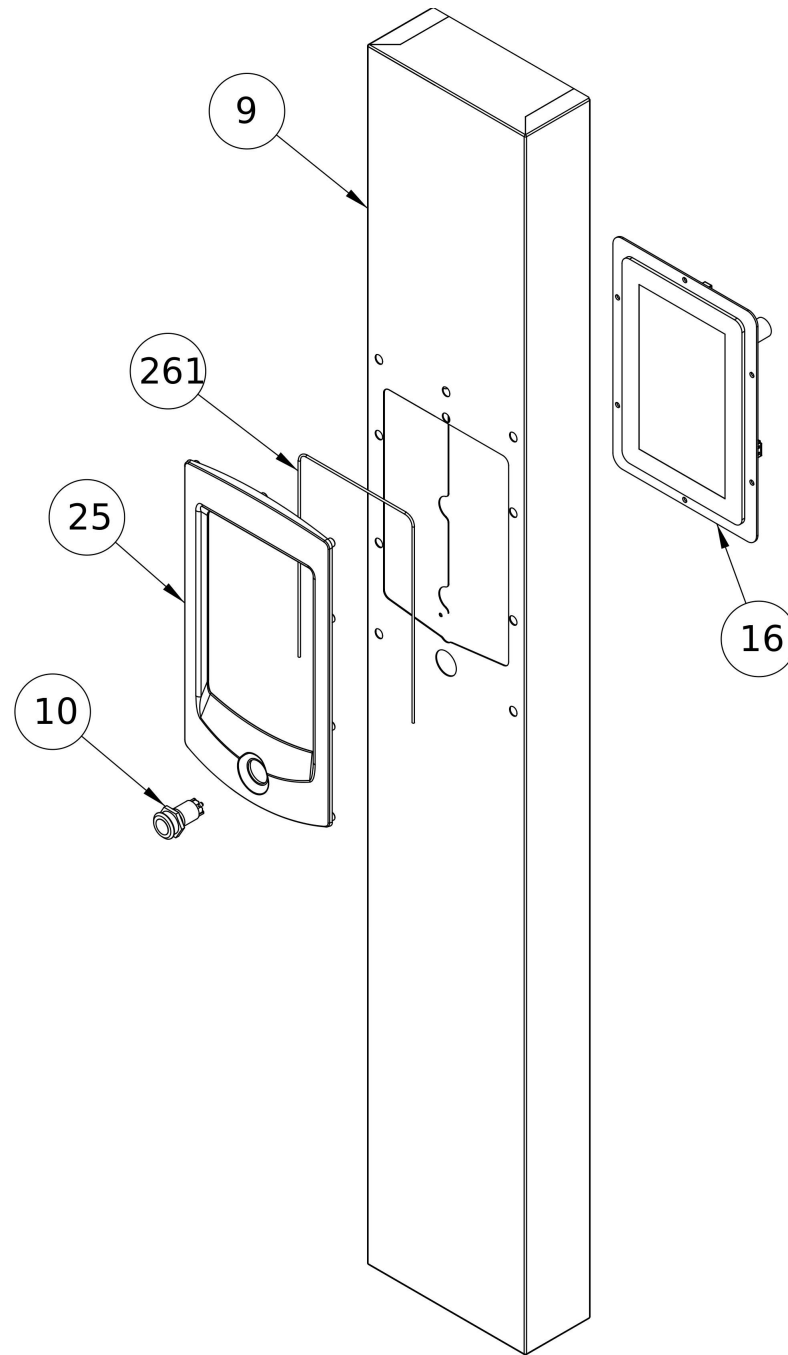

Frontal panel

#	Code	Description	Specification	UM	Qty
9	TBC-CRU	OVEN FRONTAL PANEL	To order share s/n	pz	1
10	020PUL0003	SWITCH FOR TOUCH SCREEN OVENS		pz	1
16	020SCH0010_B	DISPLAY PC BOARD FOR TOUCH SCREEN OVENS		pz	1
25	040SCA00002	PLASTIC COVER		pz	1
261	040GUA00012	GASKET		pz	1

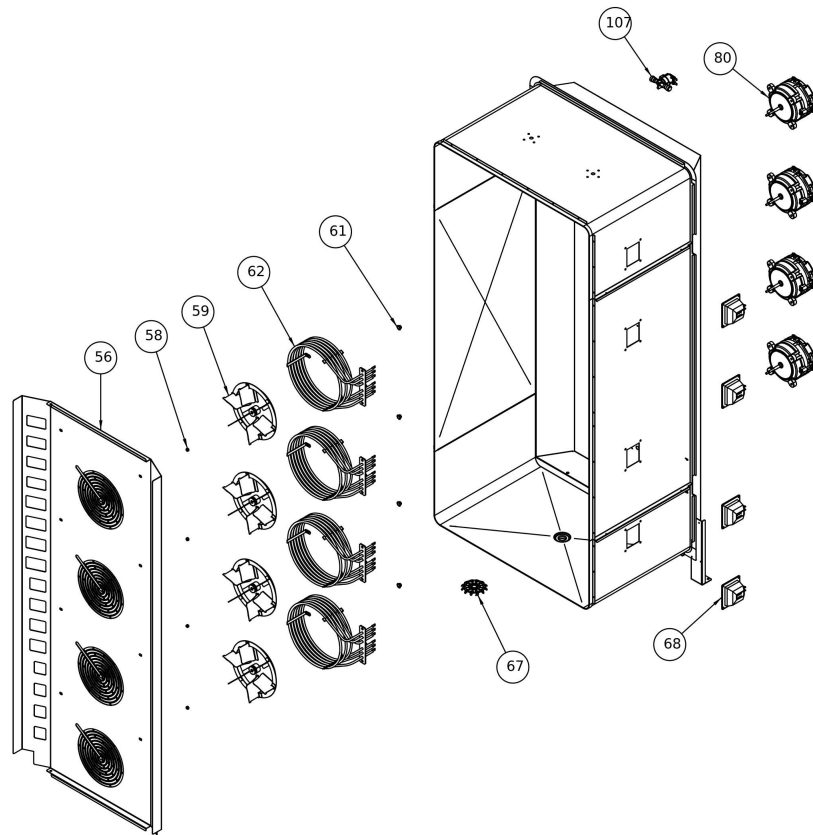

Cooking chamber

#	Code	Description	Specification	UM	Qty
56	10DEF00025	AIR DEFLECTOR		pz	1
58	70DAD00019	NUT PN M8 SS		pz	4
59	60VENAI013	IMPELLER 200X61 AIRTEK 2.0		pz	4
61	040BOC00006	CRANKSHAFT BUSH		pz	4
62	020RES10524023635	HEATING ELEMENT 10,5 KW		pz	4
67	85PIA00007	DRAIN COVER		pz	1
68	020LAM0004	HALOGEN LAMP HOLDER		pz	4
80	020MOT0027	MOTOR 230V 50/60 HZ M8		pz	4
80	TBC-MOT	MOTOR	To order share s/n	pz	4
107	020ELE0006	SINGLE SOLENOID VALVE FOR 20 TRAYS OVEN		pz	4

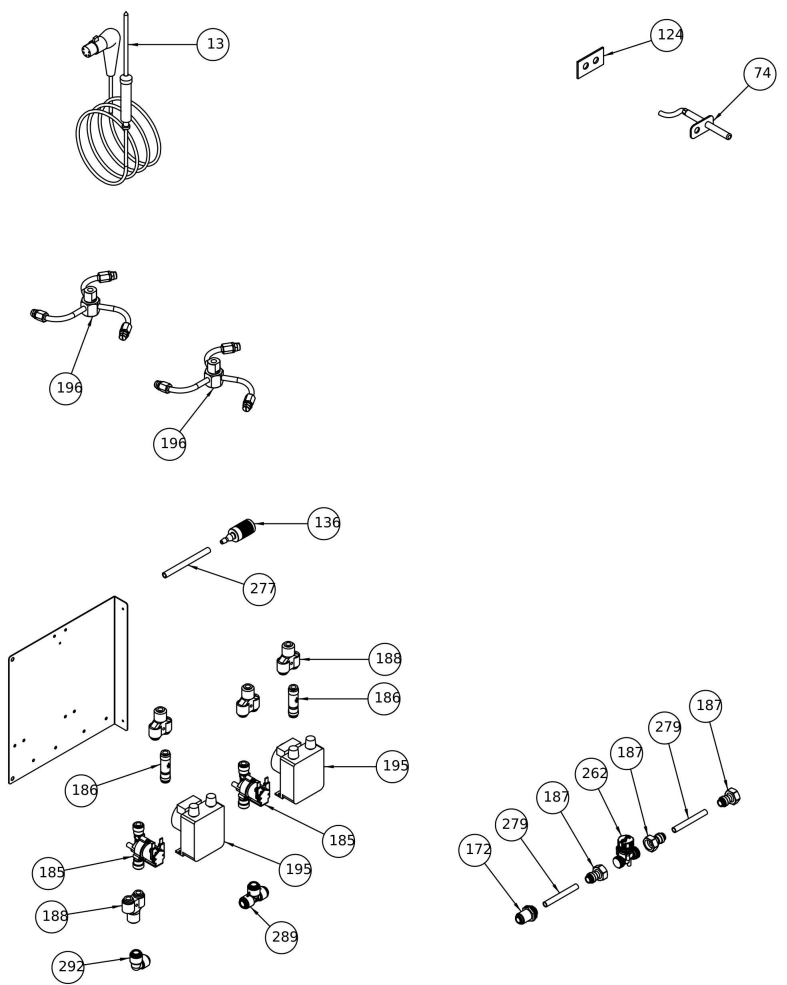

#	Code	Description	Specification	UM	Qty
13	020SON0006	CORE PROBE		pz	1
74	020SON0001	TEMPERATURE PROBE		pz	1
124	040GUA00007	GASKET FOR PROBE		pz	1
136	50FFO0002	FILTER		pz	1
172	040RAC00012	PLASTIC CONNECTOR		pz	1
185	020ELE0004	SELF CLEAN SOLENOID VALVE		pz	2
186	040RAC00005	CHECK VALVE IN/OUT JG 8MM 5/16SCV		pz	2
187	040RAC00011	PLASTIC 3/4 VALVE		pz	3
188	040RAC00003	Y JOINT 5/16		pz	4
195	020PMP0002	DETERGENT PUMP		pz	2
196	60S3	SELF CLEAN ROTOR		pz	1
262	040FIL003	120MESH IN/OUT 3/4		pz	1
277	30TUBPVC003	PLASTIC WATER PIPE PVC 6X9		cm	200
279	30TUBP12009	TUBE		cm	150
289	040RAC00014	T JUNCTION		pz	2
292	040RAC00017	ELBOW REDUCTION		pz	1

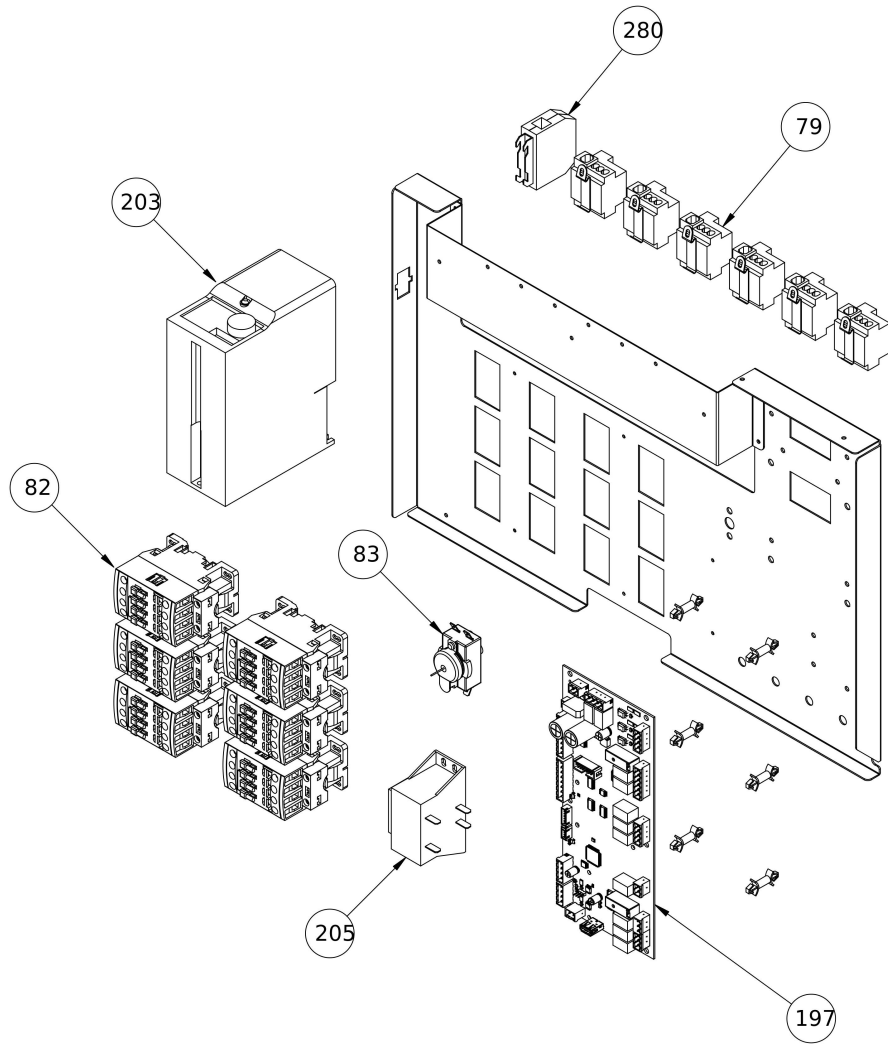

#	Code	Description	Specification	UM	Qty
79	TBC-MOR	POWER SUPPLY CONNECTOR	To order share oven s/n	pz	6
82	020TEL0003	BRAKER 4POLES 230V 25A		pz	6
83	020TER0007	SAFETY THERMOSTAT		pz	1
197	020SCH0010_A	PC BOARD 8XPT1000		pz	1
203	020INV0002	INVERTER OVEN SG10/SM12		pz	1
205	020TRS0001	TRASF. METH 230V-12V T5 20VA		pz	1
280	TBC-TER	EARTH CONNECTOR	To order share oven s/n	pz	1