

EXPLODED VIEW OF
WKS710SM(BLF-1566G)

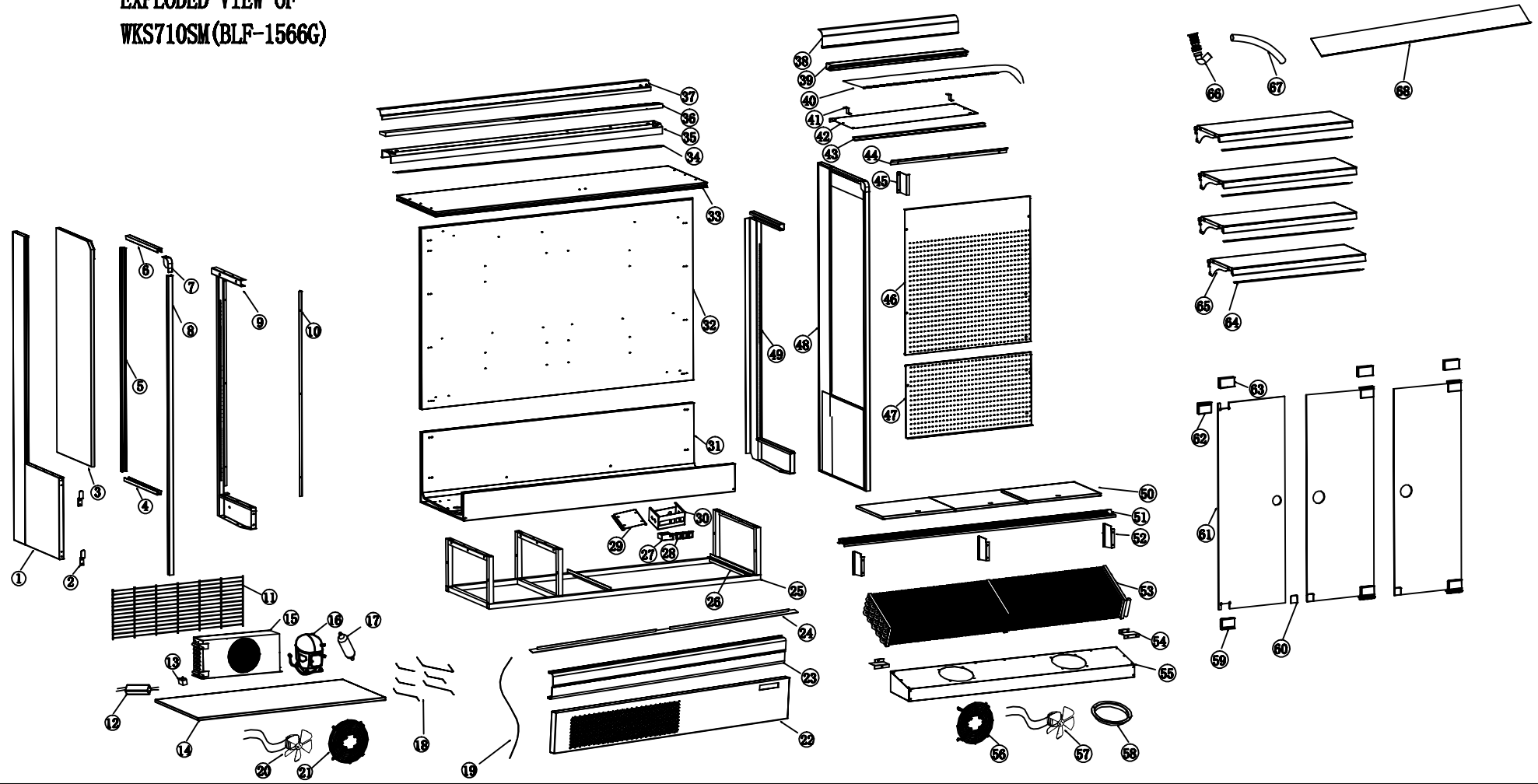

SPARE PART LIST OF WKS710SM(BLF-1566G)				
1	Foaming side panel	1		
2	Side panel glass front edge strip support	2		
3	Whole machine vertical cabinet side glass (660)	2		
4	The whole machine vertical cabinet side glass edging - down (660)	2		
5	Whole machine vertical cabinet side glass edging - rear (660, 780)	2		
6	Whole machine vertical cabinet side glass edging - up (660)	2		
7	Side panel corner - black	2		
8	Whole machine vertical cabinet side glass edging - front (660, 780)	2		
9	Side support - left component	1		
10	Inner rear plate support	4		
11	Cabin rear grille	1		
12	LED light power supply	1		
13	Relay	1		
14	Unit tray	1		

15	Condenser	1		
16	compressor	1		
17	Dry filter	1		
18	Unit piping	1		
19	Capillary	1		
20	Condensing fan	1		
21	Condensing fan grille	1		
22	Cabin front hood	1		
23	Box front cover	1		
24	Front cabinet	1		
25	Cabin rack assembly	1		
26	Unit tray support	2		
27	Electronic thermostat	1		
28	electronic switch	3		
29	Thermostat panel hanging board	1		
30	Thermostat panel	1		
31	Foaming box - lower assembly	1		
32	Foaming box - medium component	1		
33	Foam box-top assembly	1		
34	dome light	1		
35	Lampshade	1		
36	Scatter block	1		

37	Air outlet front air deflector	1		
38	Upper beam	1		
39	Upper cover support	1		
40	Inner top plate heating wire	1		
41	Inner roof support	2		
42	Inner roof	1		
43	Scatter block support	1		
44	Rear air deflector	1		
45	Inner rear plate support	3		
46	Inner rear plate - upper	1		
47	Inner rear plate - down	1		
48	Side panel - right component	1		
49	Side support - right component	1		
50	Backplane assembly	3		
51	Return air outlet	1		
52	Return air support	2		
53	Evaporator	1		
54	Evaporator baffle	2		
55	Evaporative fan cover assembly	1		
56	Evaporating fan grille	2		
57	Evaporating fan	2		
58	Evaporating fan flange	2		

59	Lower hinge	3		
60	Door clamp	3		
61	Plexiglass door	3		
62	Upper hinge	3		
63	Upper hinge support block	3		
64	Baffle light strip	4		
65	Partition assembly	4		
66	Drain pipe assembly	1		
67	Drain pipe	1		
68	Evaporator cover	1		
69				