

CONTENTS

A	GENERAL INFORMATION	Page 2
A1	PRODUCT DESCRIPTION	Page 3
A2	TECHNICAL INFORMATION	Page 3
A3	TRANSPORTATION	Page 4
A4	UNPACKING	Page 4
B	INSTALLATION	Page 4
C	SAFETY INSTRUCTIONS	Page 5
D	OPERATION	Page 6
E	CLEANING & MAINTENANCE	Page 7
F	TROUBLESHOOTING.....	Page 8
G	SPARE PART LIST- EXPLODING DRAWING	Page 9
H	ELECTRIC CIRCUIT SCHEMA	Page 13

A GENERAL INFORMATION

Before installing the appliance, read operation and maintenance instructions carefully. Wrong installation and part changing may damage the product or may cause injury on people. These are not in our company's responsibility to damage the appliance intentionally, negligence, detriments because of disobeying instructions and regulations, wrong connections. Unauthorized intervention to appliance invalidates the warranty.

1. This instruction manual should be kept in a safe place for future reference.
2. **Installation should be made in accordance with ordinances and security rules of that country by a qualified service personnel.**
3. This appliance has to be used by trained person.
4. Please turn off the appliance immediately in the event of malfunction or failure. The appliance should be repaired only by authorized service personnel. Please demand original spare part.

COLD BANQUET TROLLEY

A1 PRODUCT DESCRIPTION

*The Professional Cold Banquet Trolley, that provides high efficiency has been designed to be used in industrial kitchens.

Product Code	Dimensions (mm)	Weight (kg)	Packaging Dimensions (mm)
BWKE1211	536x920x1480		
BWKE1221	740x1036x1480	94	

A2 TECHNICAL INFORMATION

Product Code	Operating Temperature (°C)	Capacity	Power (KW)	AMPERE (A)	Operat. Volt. (V)	Cooler Gas	Gas Weight (GR)	Cable (mm ²)
BWKE1211	+0 / +5 Tropikal 43	12xGn 1/1	0,2	0,8	220V	R-134A	100	3x1,5
BWKE1221	+0 / +5 Tropikal 43	12xGn 2/1	0,2	0,8	220V	R-134A	100	3x1,5

A3 TRANSPORTATION

*This appliance can not be moved by hand from area to area. It must be moved on pallet with forklift truck.

A4 UNPACKING

*Please unpack the package according to the security codes and ordinances of current country and get rid from the pack. Parts which contacts with food are produced by stainless steel. All plastic parts are marked by material's symbol.

*Please check that all the parts of appliance had come completely and if they are damaged or not during the shipping.

B INSTALLATION

*Please place the product to straight and sturdy ground, please take necessary steps against possibility of overturn.

*Technician who will serve for installation and service for the appliance must be professional on this subject and must have installation and service licenses by the company.

*Connection to Electric Power Supply must be done by authorized person.

*Please be sure that the voltage connected to appliance must be equal with the voltage which is on appliance's label.













This appliance must be connected to an earthed outlet in accordance with safety rules and standards.

*Appliance's earthing must be connected to earthing line on panel which is nearest to electric installation.

*Connection to the main fuse and leak current fuse must be done in accordance with the current regulations.

COLD BANQUET TROLLEY

C SAFETY INSTRUCTIONS

-  *Do not use the appliance in insufficient lighted place.
-  *Do not touch the moving attachments while the appliance operates.
-  *Do not install the appliance in the presence of flammable or explosive materials.
-  *Do not operate the appliance when the machine is empty.
-  *Do not load so less or more than appliance's capacity.
-  *Do not attempt to use the appliance without suitable protective equipments.
-  *Because of any reason if there is a fire or flame flare where the appliance is used, turn off all gas valves and electric contactor switch quickly and use fire extinguisher. Never use water to extinguish the fire.
-  *All the damages because of not having earthing connection will not be on warranty.
-  *Get the necessary cautions against electric danger.
-  *Do not leave the door open while moving the banquet trolley. It may be dangerous to move the door without control. Unplug and leave the plug on the trolley.

D OPERATION

*Control Panel;

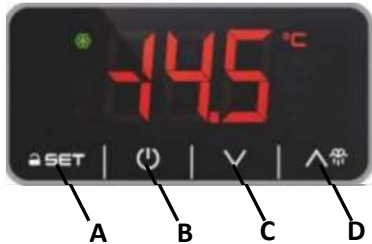

- A : SET Button
- B : ON/OFF Button
- C : Down Arrow Button
- D : Up Arrow Button

*Operating;

- Be sure that the inside of the trolley is clean and the trolley is constant to where it is before starting any process.
- Plug in the appliance.
- Switch to ON position.
- After Indicator lamps signal, inside temperature will be shown.
- You can fill the banquet trolley during cooling process..In this situation cooling time will be a little bit longer.
- After Cooling Starts ;
 - Switch to OFF position. All lamps will be off.
- Unplug it and leave the plug on the trolley.

COLD BANQUET TROLLEY

E CLEANING & MAINTENANCE

➤ **CLEANING AND MAINTENANCE AFTER EVERY USE**

- Always turn off the appliance and disconnect from the power supply before cleaning.
- Clean the inside of appliance after every use.
- Clean the inside and outside of the appliance with moist cloth and then dry.
- Do not use abrasive cleaning chemicals as these can leave harmful residues.
- Do not clean the appliance by spraying water directly, otherwise electric motor may get damaged.

➤ **PERIODIC CLEANING AND MAINTENANCE**

- Maintenance should be done by qualified person.
- Get the periodic maintenance of the appliance once in every 15 days.
- Check the wheels, electric connections, fan, control system, door and door lock once in every 6 months.
- Check the door wick in periodic time and set. Change the wicks that can not be used.

F TROUBLESHOOTING

THE APPLIANCE DOESN'T OPERATE	<ol style="list-style-type: none">1. Check if the appliance is plugged in.2. Check the electrical connections and voltage.
THE APPLIANCE DOESN'T COOL	<ol style="list-style-type: none">1. Check if the thermostat control panel operates or not.2. Fan may have error. In this situation inform the service.3. If the control system has error, the appliance doesn't cool.
THE APPLIANCE STOPPED	<ol style="list-style-type: none">1. The appliance can stop due to low voltage. In this situation check the voltage.2. If there is any load on banquet trolley, the appliance may stop.
THE BRAKES CAN NOT BE APPLIED	<ol style="list-style-type: none">1. Brakes and Wheels may have error. In this situation inform the service.
DOOR IS NOT CLOSED	<ol style="list-style-type: none">1. The banquet trolley may be overloaded2. Door lock may have error.

- If cooling is not done at suitable quality
- If any function of security doesn't work
 - Do not use the appliance.

***If these problems are still going on, contact with our authorized services.**

COLD BANQUET TROLLEY

G SPARE PART LIST-EXPLODING DRAWING

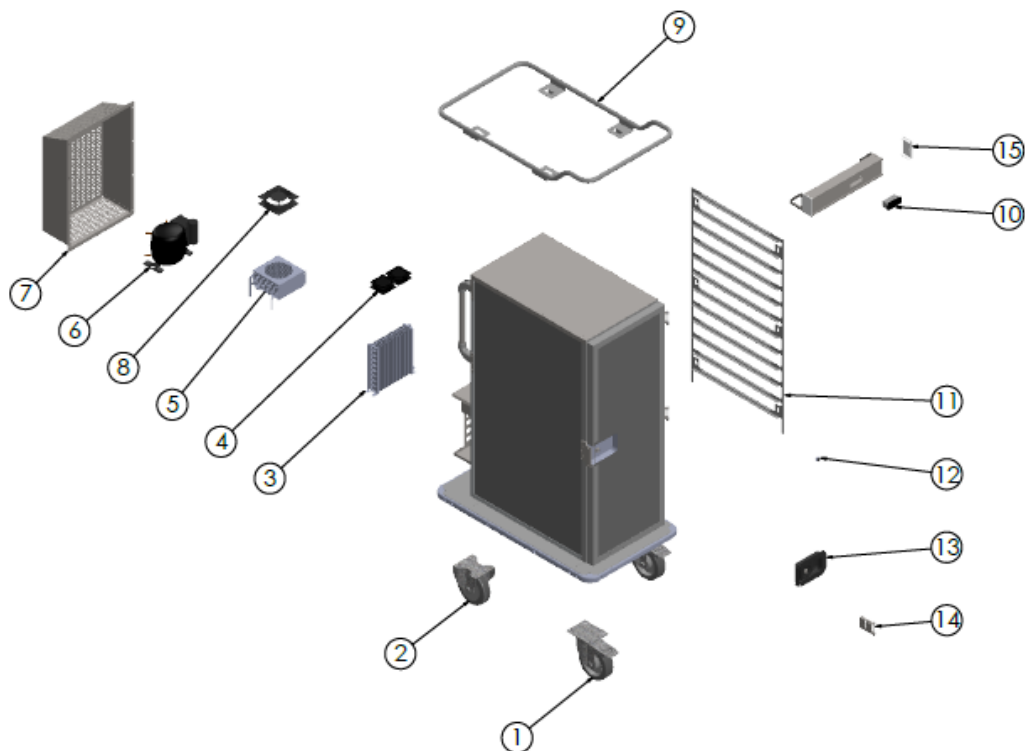

BWKE1211 – BWKE1221

G SPARE PART LIST-EXPLODING DRAWING

PRODUCT CODE: BWKE1211		
NO	PRODUCT NAME	P.CODE
1	BRAKE WHEEL	Y.EMP.BQ1-12C.001
2	BRAKE FIXED WHEEL	Y.EMP.BQ1-12C.002
3	EVAP	Y.EMP.BQ1-12C.003
4	EVAP FAN	Y.EMP.BQ1-12C.004
5	CONDENSER	Y.EMP.BQ1-12C.005
6	COMPRESSOR	Y.EMP.BQ1-12C.006
7	MOTOR GROUP SHUTTER SHEET	Y.EMP.BQ1-12C.007
8	CONDENSER FAN	Y.EMP.BQ1-12C.008
9	UPPER BALCONY PIPE	Y.EMP.BQ1-12C.009
10	DIGITAL DISPLAY	Y.EMP.BQ1-12C.010
11	SHELF SHEET	Y.EMP.BQ1-12C.011
12	MAGNET	Y.EMP.BQ1-12C.012
13	DOOR LOCK	Y.EMP.BQ1-12C.013
14	HINGE	Y.EMP.BQ1-12C.014
15	PANEL SIDE COVER	Y.EMP.BQ1-12C.015

PRODUCT CODE: BWKE1221		
NO	PRODUCT NAME	P.CODE
1	BRAKE WHEEL	Y.EMP.BQ2-12C.001
2	BRAKE FIXED WHEEL	Y.EMP.BQ2-12C.002
3	EVAP	Y.EMP.BQ2-12C.003
4	EVAP FAN	Y.EMP.BQ2-12C.004
5	CONDENSER	Y.EMP.BQ2-12C.005
6	COMPRESSOR	Y.EMP.BQ2-12C.006
7	MOTOR GROUP SHUTTER SHEET	Y.EMP.BQ2-12C.007
8	CONDENSER FAN	Y.EMP.BQ2-12C.008
9	UPPER BALCONY PIPE	Y.EMP.BQ2-12C.009
10	DIGITAL DISPLAY	Y.EMP.BQ2-12C.010
11	SHELF SHEET	Y.EMP.BQ2-12C.011
12	MAGNET	Y.EMP.BQ2-12C.012
13	DOOR LOCK	Y.EMP.BQ2-12C.013
14	HINGE	Y.EMP.BQ2-12C.014
15	PANEL SIDE COVER	Y.EMP.BQ2-12C.015

H ELECTRIC CIRCUIT SCHEMA

