



HOOD TYPE DISHWASHER (DSOZ445) USER'S MANUAL



PRODUCTION YEAR :	SERIAL NO :
-------------------	-------------



www.ggmgastro.com
Tel: + 49 (0) 2553 / 7220 0

GGM Gastro International GmbH
Weinerpark 16
48607 Ochtrup
Germany

E-Mail: info@ggmgastro.com
Fax: +49 (0) 2553 / 7220 200



TABLE OF CONTENTS

TOPICS	PAGE
1-INTRODUCTION	3
2-TECHNICAL DATA	4
3-WARNING SIGNS AND SAFETY DETAILS	6
4-TRANSPORTING AND MOVING	7
5-OPERATION OF THE MACHINE	12
6-CLEAN-UP AND MAINTENANCE	19
7-ELECTRICAL CIRCUIT DIAGRAM	20
8-TROUBLESHOOTING	21

1-INTRODUCTION

Dear User,

Thank you for purchasing our device and for your reliance upon our company. Our devices have been used within our customers kitchen, your kitchen in 100 countries. Our devices are produced in compliance with international standards. Important notice: Please read or ensure that the users read this user's manual in order to achieve the desired performance in line with your expectations and to use your device for long years. Please take the warnings mentioned above into consideration before calling for service...

- Please read and ensure that your operation personnel also reads this user's manual carefully before installing and using the device. If the device is operated without reading the user's manual, the device will not be covered by the guarantee.
- The manual containing information about installation, usage and maintenance of our product you purchased should be read carefully. Please ensure that power supply connections to the device are already installed by qualified personnel according to local legislation, before our authorized service personnel arrives for the installation of the device.
- If you are confused or you don't have enough information please get in touch with authorized service by phone.
- Please keep in mind that, if the service personnel is delayed at your site, related expenses and delay costs will be charged to you on hourly basis.
- We hope that you will get the best performance from our product...

2-TECHNICAL DATA:

MODEL	DSOZ445
Code	071D.11014G.BB
Total Rating	400 V ~ 3NPE/50 Hz
Total Rating(kW)	9,66
Washing Capacity (Plate/Hour)	1108
Washing Capacity (Basket/Hour)	69/35/27/23/18
Washing/Boiler Tank Capacity	19/7
Washing Program Number	4
Program Times(sn.)	60/90/120/150
Washing Water Temp. (°C)	55-60
Rinsing Water Temp. (°C) max.	80-85
Water Inlet Connection	3/4 "
Water Inlet Pressure (Bar)/Temp.	2-4 Bar / 50 °C
Heat Power (Washing/Rinsing)	2 / 9 kW
Dirty Water Discharge Connection	1 1/4" (Ø 42 mm)
Gross Weight	110 (±5) kg
Dimensions (WxDxH) (mm.)	700x790x1420(1860)
Protection Class	IPX5
Rack Dimension (cm.)	50x50
Loading Height	380 mm
Inclination	6°
Washing Pump Power (kW)	0.66
Rinsing Pump Power (kW)	-
Detergent Pump	+
Rinse Aid Pump	+
Rinsing Pump	-
Drain Pump	+
Electrical Connection Cable / Flexible Water Supply and Drain Hose	+
Stainless Steel Washing Arms	OPTIONAL

2.1 Device Dimensions:

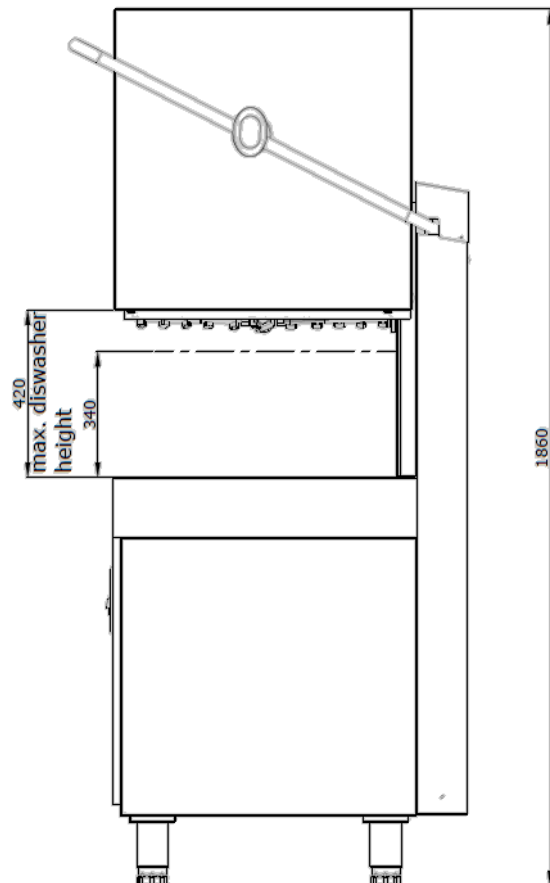
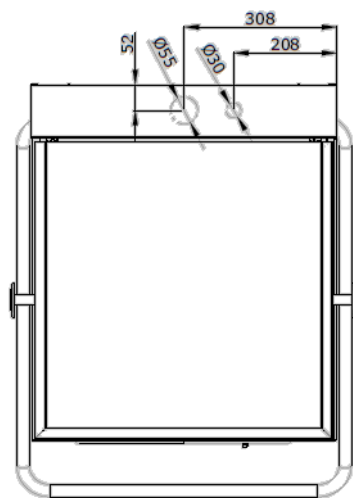
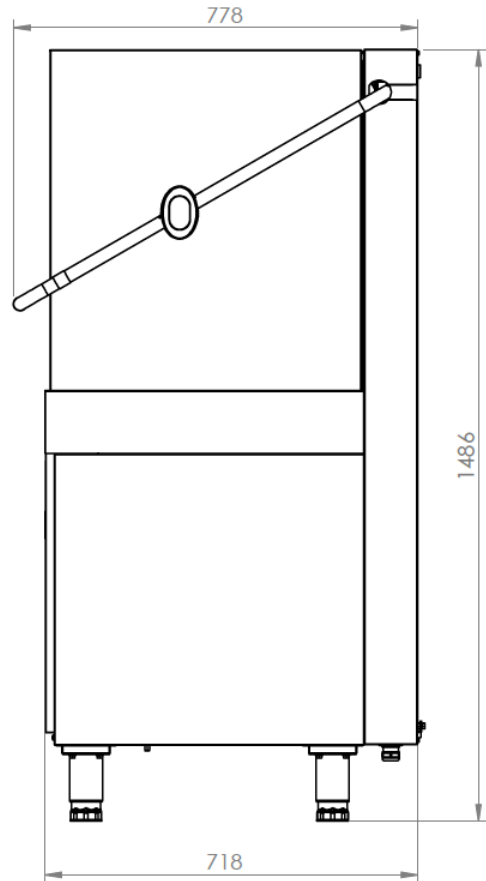
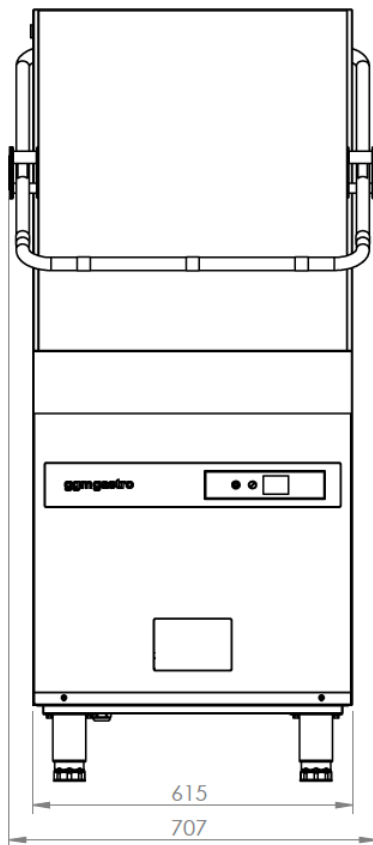

3- WARNING SIGNS AND SAFETY DETAILS

3.1 Warning Signs

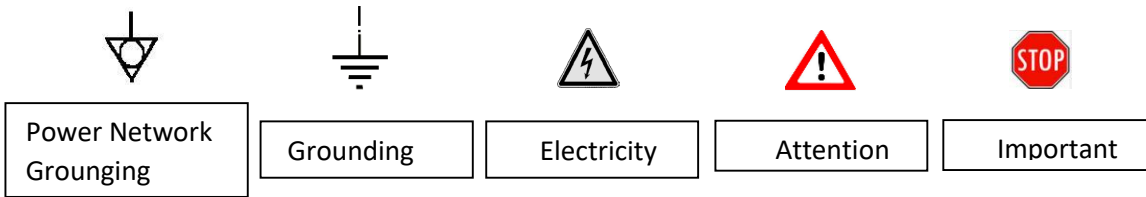

- The machine should never be exposed to direct sunlight.
- The machine should never be left in water and its outer surface should never be cleaned with high pressure water.
- This machine is designed for industrial use and should only be operated by personnel trained according to this manual.
- This machine must be installed according to effective regulations. It should only be operated in places that are ventilated well or under a chimney hood. Otherwise, hot water steam and excess moisture produced by your machine or other devices within the kitchen may damage the mechanical and electrical parts of your machine. Ambient humidity should not exceed 65%.

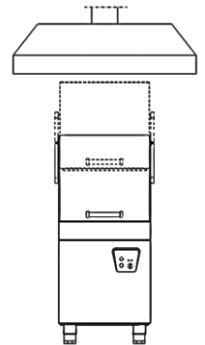

Ambient temperature where the machine is operated should be between (+5 °C / +40 °C).

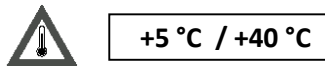

- If the machine is fed with hot supply water, water inlet temperature should not exceed maximum + 50 °C.
- The machine is designed to operate with softened water at a French water hardness level of (0 -10). Excess calcium in water supply may damage moving parts of the machine and decrease washing performance of the machine. For this reason daily maintenance as described in the section (CLEAN-UP AND MAINTENANCE Page -18) should be carried out regularly.
- The machine should not be dislocated when operating.
- If the machine has to be operated subsequently, then it should be paused for 1 hour for every 4 hours of operation.
- OUR COMPANY IS NOT RESPONSIBLE FOR POSSIBLE FAILURES THAT MAY OCCUR AT DETERGENT SYSTEM CONNECTIONS. THEREFORE WE RECCOMENT YOU TO COOPERATE WITH PROFESSIONAL DETERGENT COMPANIES EMPLOYING ELIGIBLE INSTALLATION PERSONEL.
- LOW QUALITY DETERGENT MAY HARM OPERATING SYSTEM AND PLASTIC COMPONENTS OF THE DEVICE. THEREFORE WE REMIND YOU TO CHOOSE APPROPRIATE TYPE OF DETEREGENT.
- WE DO NOT USE CLEANING CHEMICALS CONTAINING LAUNDRY WATER, CHLORIDE OR HYPOCLORURE.
- CLEANING MATERIALS MUST NOT BE USED AS STEEL SPONGE AND WIRE BRUSH.



WE RECCOMEND YOU TO TREAT THE SUPPLY WATER IN A PURIFICATION SYSTEM BEFORE USING, IF IT HAS A HARDNESS HIGHER THAN 0 - 10 FRENCH HARDNESS LEVEL.



4- TRANSPORTING AND MOVING



- The machine should be placed vertically on a palette by manpower.
 - Transportation should be carried out by inserting the forklift forks under the machine.
 - If the transported distance is far, the machine should be moved slowly and fixed to the palette or supported by another personnel to prevent jolt, if necessary.
 - Do not hit or drop the machine when moving.
- Producer company is not responsible for the damage occurring during transportation of the machine.



CHANGING THE LOCATION :

Machines installed by an authorized service **CANNOT BE MOVED ELSEWHERE, ITS CONNECTION HOSES AND CABLES CANNOT BE EXTENDED OR REPLACED** except by an authorized service.

4.1 Installation Diagram

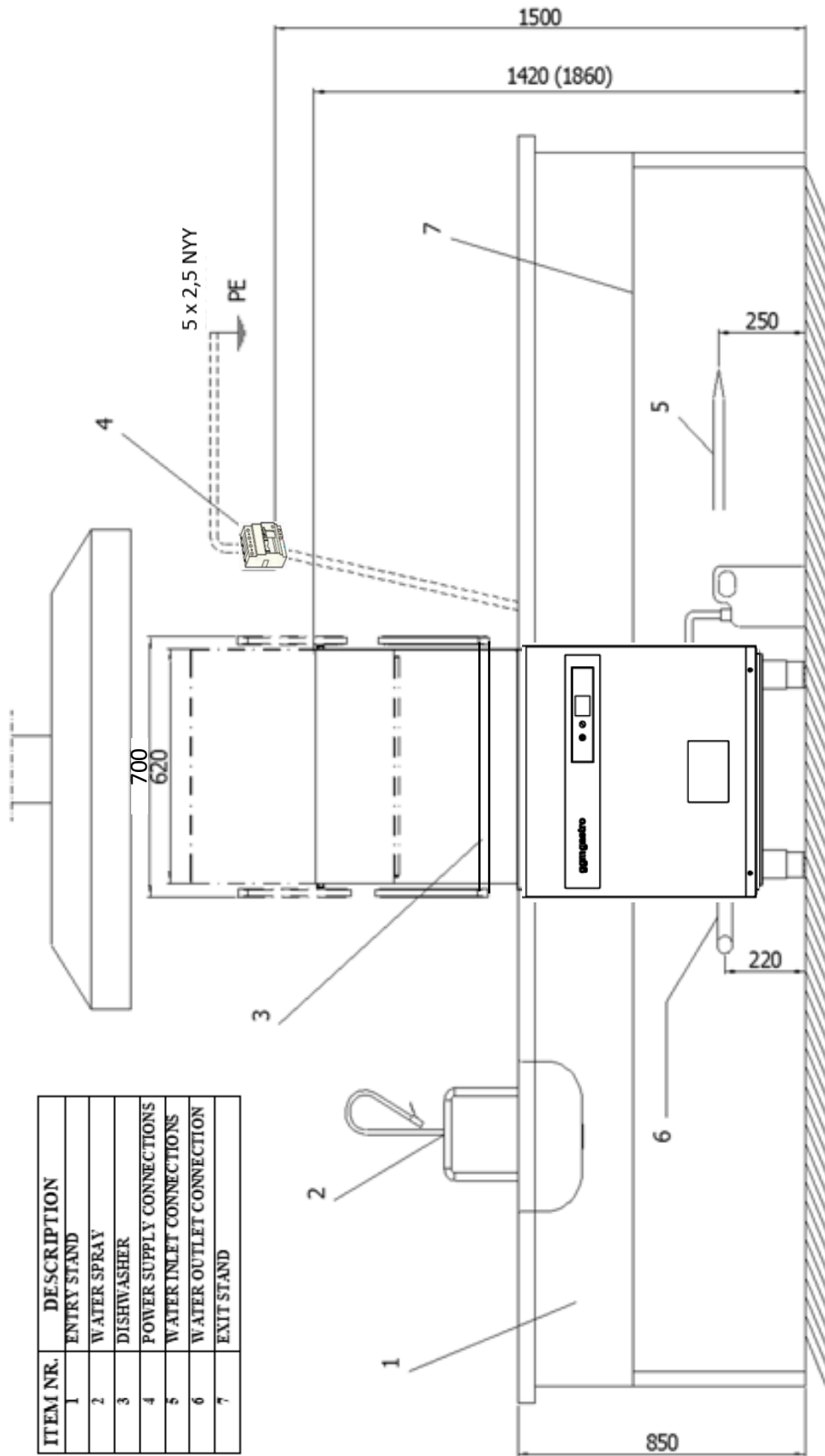

NOTE: Dimensions are given in mm.

4.3 Electrical Connections:

- All electrical connections must be made by authorized service personnel in accordance with local and national standards and directives.
- All products must be connected to the residual current device of 30mA.
- Use the power socket and an appropriate connector to connect the appliance. Power socket is on the side. This connection is additional to existing grounding.
- Before connection, make sure that rated voltage on the name plate matches the mains voltage. Furthermore, also the fuse rating should match product specifications.
- If power cable is damaged, please obtain a replacement from Öztiryakiler or authorized service.
- Electrical ratings are marked on the product's name plate.

4.4. Water Connection:

- A 3/4" water inlet hose is provided with the appliance. Use this hose for water connection and check water tightness on connections and the hose.
- When installing the appliance, use the new hose provided. Avoid using old damaged hoses.
- Washing performance of the product depends on external conditions such as water inlet temperature, pressure, hardness and chemicals used (detergent, polisher). To increase the service life and washing performance of the appliance, supply water should have proper hardness. Otherwise, use a water softening device.

Caution! Any damage resulting from the use of hard water will not be the manufacturer's or dealer's liability, and voids the product warranty.

4.5. Limits in Water Connection:

- Water inlet temperature: 4-50°C.
- Inlet pressure of flowing water: A rinsing pump is needed if pressure is 0-2 bars. A pressure of 2-4 bars is appropriate. If pressure exceeds 4 bars, adjust the pressure using the pressure regulator.

If these conditions cannot be satisfied, appliance's washing performance would decline.

4.6. Drain Connection:

4.6.1. Models Without a Drain Pump:

- In models without a drain pump, waste water is transferred to the drain vent by gravity. Drain hose should run to the drain vent with a downward slope. Therefore, drain vent height should be max. 100 mm. Never reduce the diameter of the drain hose.
- Allow a adequately long drain hose so that the appliance can safely be moved during servicing. Drain vent diameter should be $\varnothing 42$ mm (1 1/4") and drain should be below the hose outlet level. Make sure that the hose-drain vent connection is watertight.

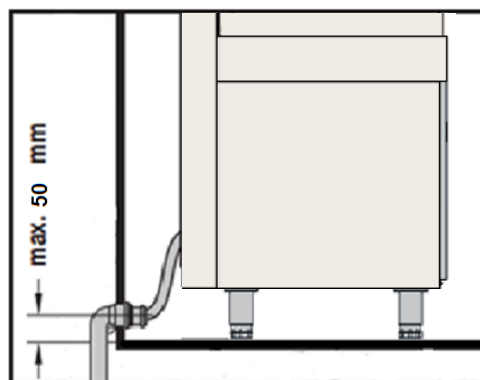

4.6.2. Models With a Drain Pump:

- If drain vent is below the appliance's drain outlet, attach the hose to the drain vent with a downward slope. Otherwise, drain vent height should be 60 cm max. The Ø28 mm (3/4") drain vent should not be below the appliance base.

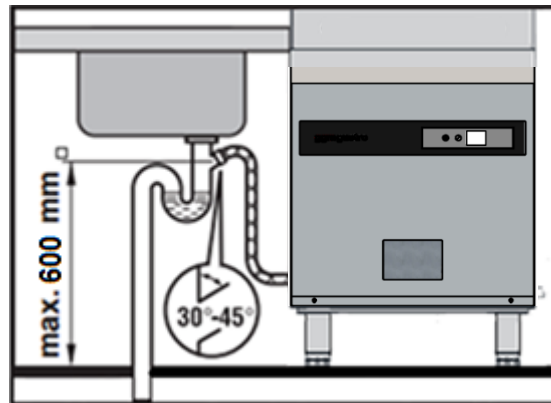

Please call the authorized service or dealer for drain problems.

4.7. Loading Detergents and Rinse Aid:

Chemical pumps are located on the back side of the front panel (Optional). Disconnect the appliance before removing any panel. A plastic hose is available for each chemical pump. There are hose outlets on the back side of the appliance. Attach the weights provided with the appliance to the ends of the chemical hose. Then, position the weight at the hose end below the chemical drum. Always make sure to attach the detergent hose and the rinse aid hose to the right container. (Rinse aid hose to the rinse aid drum, detergent hose to the detergent drum)

Attention: Only use chemicals suitable for industrial washing or glass washing. Rinse aid should be suitable for temperatures below 40°C as well.

4.7.1. Detergent & Rinse Aid Amount:

Detergent pump dosage is set during production, and rinse aid pump is automatically set. However, depending on actual water hardness at the place of installation, chemical dosage may be re-set on the detergent pump. Chemical pumps are located right on the back of the front bottom panel (Optional). Turning the setting knob clockwise and counter clockwise increases and decreases the chemical dose respectively.

Note: At start-up, bleed excess air in the hoses.

4.8 Washing and Rinsing Water Temperatures

Water temperatures can be adjusted. During production, our appliance is set to the following temperature values. The temperature should not be set higher than these temperatures.

Models:	ALL
Rinsing Water Temp.(Boiler)	80-85°C
Washing Water Temp.(Tank)	55-60°C

Machine Assembly

STOP 4.9. Measures on the Customer Side:

- 1- Call a qualified electrician to complete the electrical connection of the appliance. A V-type automated fuse located at a minimum height of 120 cm, and a 30 mA residual current device should be installed in the assembly.
- 2- Ground the appliance with the mains ground lead securely attached to the ground terminal of the appliance's power cable.
- 3- The appliance is delivered with a power cable (5x2.5 mm NYAF), an inlet hose with a 3/4" tap connector and a Ø42 mm drain hose (Ø28 mm for the models with a drain pump).
- 4- To supply clean water to the appliance, install a new 1/2" piping system on the rear wall at a min. height of 200 mm from the floor and terminate it with a 3/4" valve.
- 5- To discharge wastewater from the appliance, install a Ø50 PVC piping system on the rear wall at a max. height of 100 mm from the floor. Use a floor trap if the drain outlet is equipped with a grate.
- 6- Make sure that there is a hood-equipped ventilation system in the room where the appliance is installed.
- 7- Appliance's legs are adjustable. Adjust them to create a level plane on the floor.
- 8- Make sure that the room is free of steam and moisture.

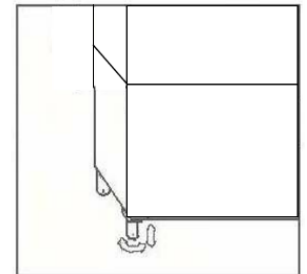
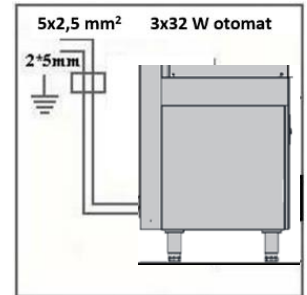

Unless customer completes these measures, the authorized service will not install the appliance.

STOP 4.10. Measures on the Authorized Service Side:

- 1- After initial measures are completed by the customer, the service member called will install electrical and water connections and start up the appliance.
- 2- Never start the appliance before the service member arrives, otherwise product warranty will be void.
- 3- Call the detergent company on the day appliance is installed, if possible. Have detergent and polisher pumps installed. Our company or service will not be liable for any damage on the appliance caused by the detergent company.

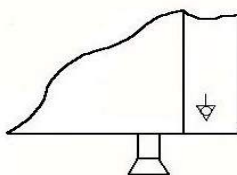

“Grounding” screw for an external connection

CAUTION! : NEVER START THE EQUIPMENT BEFORE GROUND CONNECTION IS COMPLETED

5- OPERATION OF THE MACHINE

5.1 Getting to know our device: To understand the information in the user manual correctly, the main parts of the machine should be known, please have the information by examining the picture below.

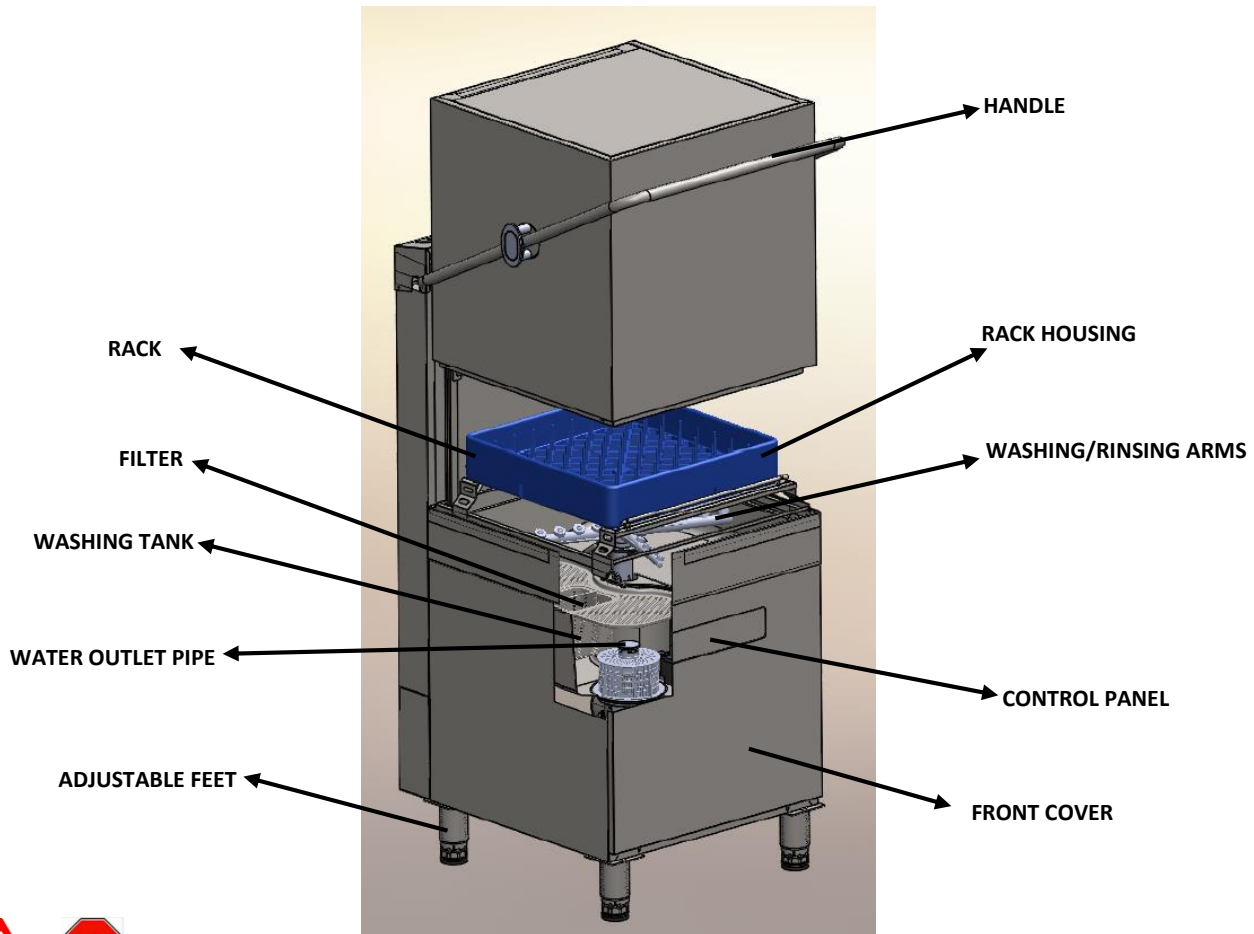

This product is used in tourism facilities, industrial kitchens, work sites, patisseries, catering companies for washing dishes. Only preparation equipment, dishes (plates, forks, spoons, knives, glasses, service trays etc.), service utensils (ladles, skimmers, spatulas, tongs, etc.) should be washed in the machine.

NOTE: Do not use for purposes other than mentioned above. Machine should be operated by a qualified personnel informed about safety terms and technical specifications and who has read the instruction manual.

STOP To ensure that the user is using the machine correctly after installation, the following items should be shown to the user;

- It should be shown how to cut off the electricity and water supply in case of emergency.
- Turning on the machine
- Working with machine
- Water discharge process
- Turning off the machine

STOP 5.2 Operation:

5.3 Description of the Appliance

Unlike domestic appliances, industrial dish and glass washers are designed for almost uninterrupted operation.

5.4 Control Panel

Please note the following warnings about the touchbuttons

- When the device is energized, no buttons should be touched until the On / Off button lights up.
- Infographic below shows the proper touch.

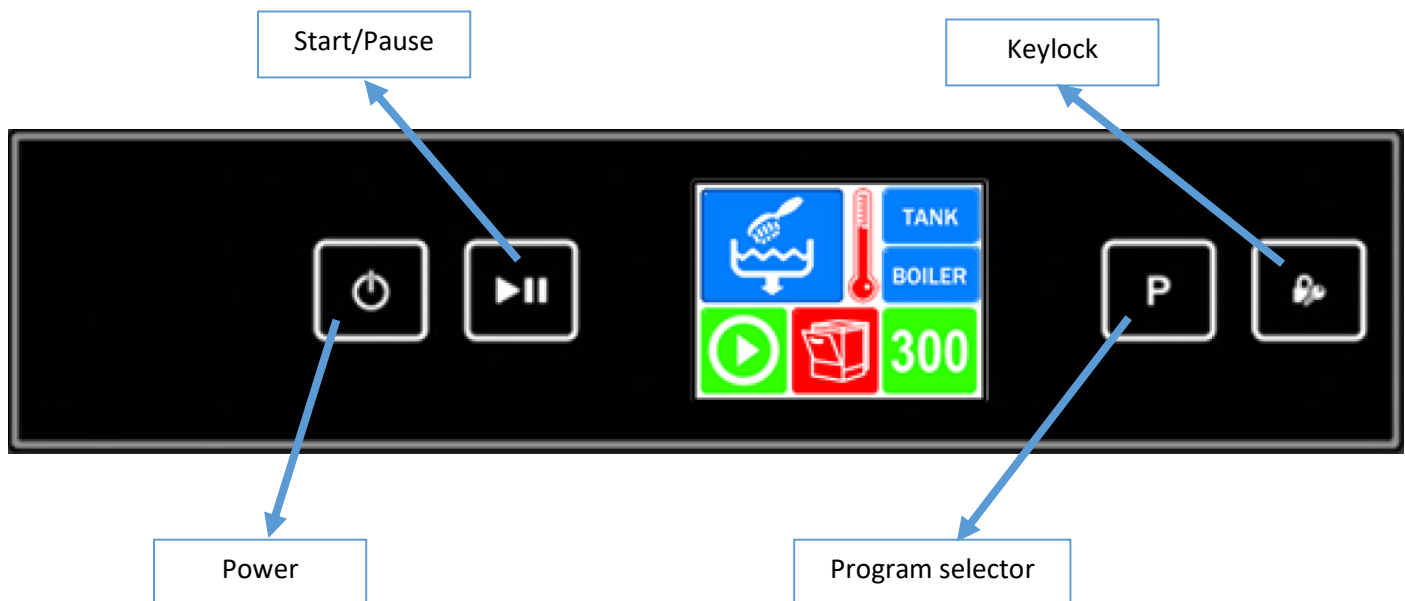



Visible when the door is properly closed



Visible when the door is open.



Indicates the number of washes in the dirt timer are completed.



Visible when the water level is low.



Appears when device is in standby and ready for operation.



Appears while washing.



Appears while rinsing.



Appears when the washcycle is completed

5.5. Switching the Device on and off:



Press the “power” button to turn on/off the device. When the device is switched off, a led indicator will turn on on the button & it will turn off then te device is working. After the water intake process completed; first Boiler, then the tank heater will activate. Both heat indicators will wink until reaching the proper temperature. When reached, status icons turn completely on & red.

5.6. Starting a Wash Cycle



When the device is switched on & is ready to start, press “Program Selector” button to select the desired program. When the device is ready to start wash cycle, led on the “start/pause” button will wink.



When you press & hold the “start/pause” button, washing will start. “Start/pause” button is not active only for one cycle. After you open & close the door, new wash cycle will start automatically. If you want to pause the



washing operation, you need to press “start/pause” button again. Please note that, this button doesn’t stop



the heating operations. The device still will be ready to wash & will start instantly when pressed “start/pause” again.



Program Indicators

60 seconds



90 seconds

120 seconds



150 seconds

5.7. Draining:









When the device is on, press “Program Selector” button and select “drain” icon.



Then press and hold “start/pause” button to start draining process. After starting the process “remove stopper” icon will appear on the screen. When you see this icon; you need to open the door, remove the stopper & close the door in order to start draining process. Draining will take 180 seconds and when completed the device will turn off automatically.



5.8 Self Cleaning:

When the device is on, press “Program Selector”  button and select “self clean”  icon. Then press and hold “start/pause”  button to start self cleaning process. “Remove stopper”  icon will appear on the screen. When you see this icon; you need to open the door, remove the stopper & close the door in order to start self cleaning process. Self cleaning will take 120 seconds and “add stopper”  icon will appear on the screen. When you see this icon, you need to open the door, place the stopper properly & close the door. Device will intake fresh water for 60 seconds. Next “remove stopper”  button will appear again for the final drainage. Repeat the stopper removal steps again. Final drainage will take 120 seconds and when completed the device will turn off automatically.

After washing the set pollution counter value in the parameters menu, “dirty device” warning  will appear on the screen. This warning has no effect on the operation of the device, but it is necessary to carry out a self cleaning in order to remove the warning from the display.

5.9 Key lock:

Press and hold “keylock”  to lock & unlock the device. The LED on the button is on when the key lock is activated.





5.10 Setting the Device Parameters:

- **Access to the parameters menu:**

Please make sure the device is switched off and the key lock is deactivated. Then please press related buttons in the following order;



- **Setting the parameters:**

When you Access the menu, press “program selector”  to switch between parameters. Below you can find the table for the parameters. When you are on the selected parameter, press “power”  to increase & “start/pause”  to decrease value. Then press “key lock”  to set the new value of the parameter. When settings are completed, press and hold “program selector”  to exit.

5.9 Deactivating the Appliance:

If you need to remove or deactivate the appliance for any reason, appropriate local or national regulations should be observed. Öztiryakiler recommends the following procedures.

- Remove chemical hoses from their drums carefully, then close the container lids to avoid chemical spillage. Refer to safety notes for the chemical drums to prevent any damage due to spillage.
- Make sure that water is fully drained off the appliance, and then remove the drain hose from the drain vent. Wipe and dry moist areas of the appliance after draining.
- Turn off the mains power supply.
- If the appliance is plugged to the plug socket, disconnect it.
- If cable terminals are connected directly to the electrical panel, call a qualified electrician to carry out the disconnection as per local and national wiring regulations.
- After disconnection, make sure that the voltage / ground wire is removed from its housing on the rear part of the appliance.
- Turn off water supply to the appliance and isolate the water inlet hose. Before proceeding with the next step, dry out any leak.
- Unscrew the bottom panel and remove it.
- Remove the boiler discharge plug and drain water into a vessel. The vessel should have a 6-litre capacity.

Attention:

If draining is to be carried out immediately after the operation, discharge water from the boiler may be 85°C.

- Then, re-place and tighten the plug.
- Re-place the front panel and make sure that all cables and hoses are securely fastened to the device to avoid any risk. It is now safe to move the appliance.

5.10. Recycling:

If you intend to recycle or dispose of the appliance, make sure that local and national regulations are observed.



NOTE:

- 1- Hardness of water supplied to the appliance should be softened to 0-10 °fH.
- 2- Extremely hard water both shortens the service life of the appliance and drops its washing performance. Calcified parts are outside the warranty coverage.
- 3- In case of continuous operation, apply a 1-hour break every 4 hours of operation.
- 4- Never move the appliance when running.

CAUTION! Take utmost care to install and operate the appliance in strict accordance with this manual. In case of a mechanical failure, please first refer to the “Troubleshooting” section in this manual, and then call our call centre to request for authorized service if necessary. Always avoid unauthorized intervention in the appliance.



5.11. Use of Detergents and Rinse Aid in the Dishwasher

1. Remove the plug on the rear part of the appliance and connect the hose from the detergent dosing unit to the wash tank using a proper coupling.
2. Dirt level of dishes and detergent characteristics should be considered to assess water hardness and consumption in the dishwasher. User should never modify the detergent dosing rate set by authorized members of the detergent company.
3. If detergent dose supplied to the appliance is increased through unauthorized intervention, excess foam would be produced, causing the dishes look dirty and detergent-contaminated after washing, and also excessive detergent consumption would occur. On the contrary, reducing the detergent dose would cause inefficient washing, resulting in non-cleaned dishes.
4. Rinse Aid pump is automatically set according to rinse water consumption and water hardness. Thanks to this automatic setting, excessive rinse aid feed and excessive foam production in the washing system is avoided and hence poor rinsing performance and dirty-looking dishes contaminated by hazardous chemical agents are prevented.
5. Another harmful effect of excess rinse aid in the rinse water is the occurrence of a higher acidic effect resulting in abrasion of the rinsing line.
6. The detergent and rinse aid used should be health-friendly.
7. It is recommended to use non-effervescent detergents and rinse aids designed for dishwashers.

6- CLEAN-UP AND MAINTENANCE

6.1 Periodical Maintenance and Clean-up

Daily maintenance should be carried out by people informed about the safety instructions as following, after disconnecting power supply and water connections.

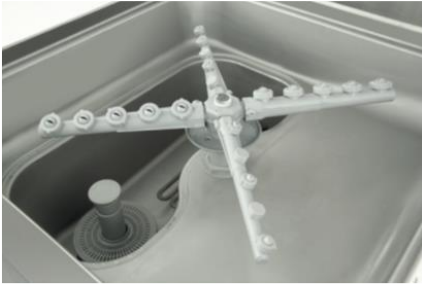

6.1.1 Daily Maintenance:

Daily maintenance should be carried by the user. In order to clean up the machine within the day following should be carried out periodically after the washing operation:



1. Wash and rinse arms should be disconnected and the scraps remaining in those arms should be removed away using pressure water, brush, fine wire etc. and reinstalled back to their places.
2. Scraps remaining in the washing tank should be removed and cleaned up. (Do not carry out washing operation without installing scrap filters)
3. If the period between two washing operations exceeds "5 Hours" water outlet pipe should be disconnected and all of the water should be drained out fully.
4. Suction filter should be disconnected and cleaned up with plenty of water.
5. Inside of the tank should be cleaned up with a sponge or cloth and plenty of water.
6. After cleaning operation is finished suction filter, water outlet pipe, scrap filters and washing and rinsing arms should be reinstalled.
7. Scale formed on the carriers of the device after certain period of use, must be wiped away. If it is not cleaned up for a long time, scale formed on the carriers of the device, hinder the free movement of the hood.

6.1.2 Periodical Maintenance:

Periodic maintenance should be carried out by the user at least once in a month, after the cleanup and maintenance that must be conducted after each washing operation is completed. This should be done when the machine is ready for operation and before the dishes are set up in the machine. After ½ kg's of decalcination substance is added to the washing tank, the machine is operated for ½ hours so that it cleans itself up. Afterwards the water within the machine is disposed and then refilled with fresh water. This time the machine is operated without any additive substance only with water for ½ hours and after the water inside is disposed, the machine will be ready for operation.

If the device is not used for long period of time, you must drain the water left inside the boiler. For this purpose, let the water drain out after opening the tap (boiler tank tap) at the lower part of the devices body. Other wise, water staying inside too long, may harm the resistances.

Rinsing Arm Washing Arm



CAUTION!

- Never use cleaning chemicals containing bleaching agents, chlorine or hypochloride.
- Never use steel sponge or wire brush for cleaning purposes.
- Do not use pressurized water to clean inner and outer surfaces of the appliance.
- Before cleaning the interior of the dishwasher, first carefully remove from the boiler any parts that may cause injury during cleaning, such as sharp glass pieces.
- Wipe clean the interior of the dishwasher. Once wastes and particles are removed, re-place the washing/rinsing arms and filters.
- Clean the outer surface of the dishwasher with a damp cloth. Never use wet cloth for cleaning.
- After drying, clean with a stainless steel cleaning article.

7-ELECTRICAL CIRCUIT DIAGRAM

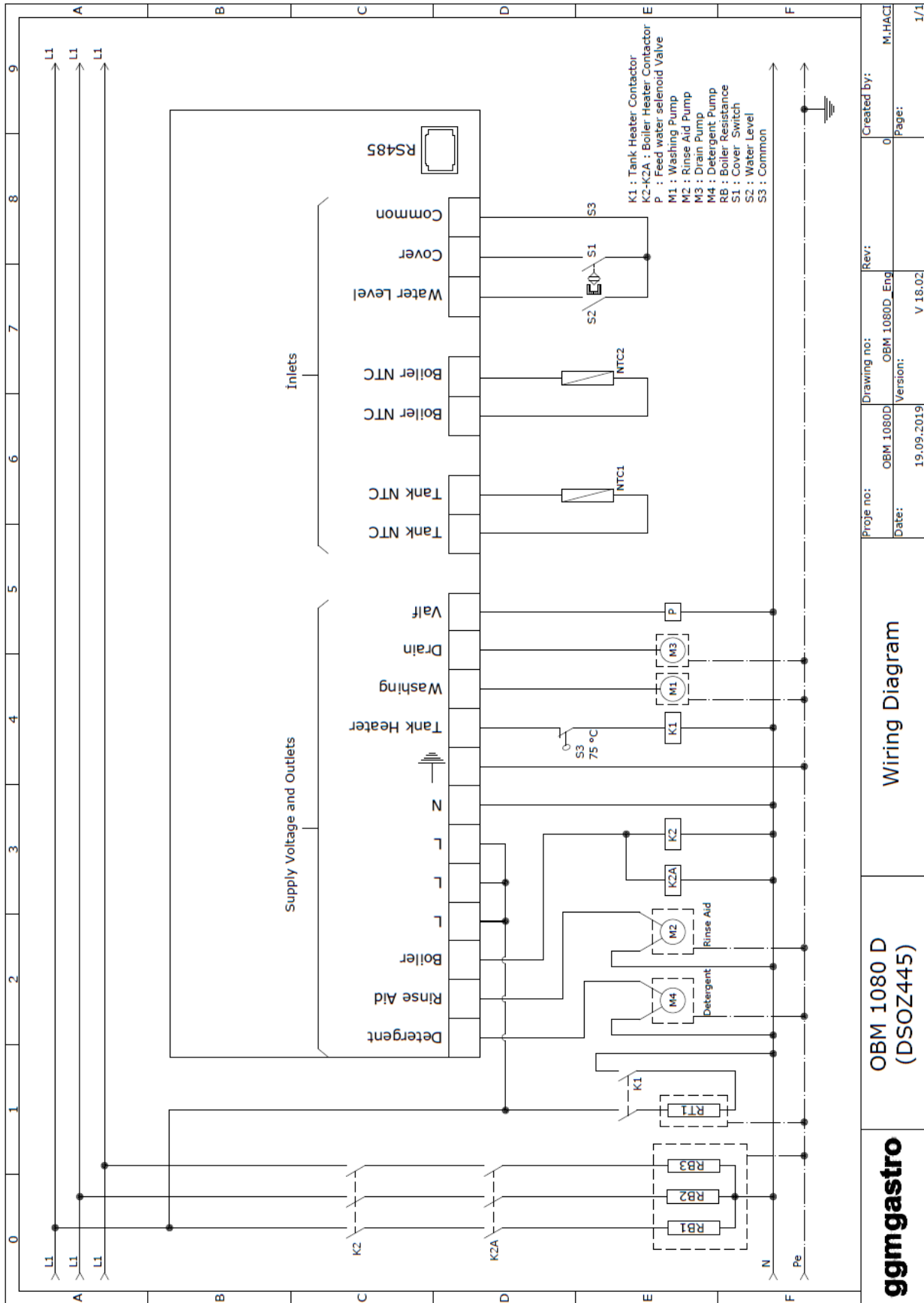

ggmgastro		OBM 1080 D (DSOZ445)		Wiring Diagram		Created by: M.HACI	
Date: 19.09.2019		Version: V.18.02		Rev: 0		Page: 1/1	
Proj. no: OBM 1080D		Drawing no: OBM 1080D_Eng		Rev: 0		M.HACI	

8- TROUBLESHOOTING



Please check the following items before calling the call centre:

1. Equipment does not run partially or completely, check the electrical supply to the appliance.

2. Check mains water and electrical connection is in place and active.

3. Electrical supply to the appliance should be 230 V~3PE/60 Hz.

4. Appliance does not run when the start button is pressed;

- One reason is that door is not securely closed and door switch contact cannot be closed. Make sure that the door is securely closed. If the appliance still fails to wash, call the call centre.
- If the machine performs washing but fails to follow the programmed sequence and waiting time, program switch is faulty. Call the call centre.

5. If the appliance fails to heat the wash water;

- The thermostat in the reservoir is faulty. Call the call centre.
- Washing reservoir resistor may be faulty due to calcification, call the call centre.
- Check the inlet water temperature. Very low or high inlet water temperature may affect the heating of process water.
- Check water level in the boiler.

6. Equipment does not heat the boiler water;

- Boiler thermostat may be faulty, call the call centre.
- Boiler resistor may be faulty due to calcification. Call the call centre.
- Contactor of the boiler resistor may be faulty. Call the call centre.

7. Poor washing performance;

- Check the detergent and polishing chemicals in the drum, replenish if necessary.
- Clean water outlet parts on washing/rinsing arms.
- Clean and properly re-place the filters.
- Make sure that water supply is fully on.
- Remove left-overs in dishes before loading the dish basket.
- Glasses may require pre-washing.
- If there are whitish spots on glasses, water hardness may be high. Call the call centre for details on using the necessary softener.

8. Appliance cannot be switched off;

- Disconnect the mains electrical supply, and call the call centre for technical service.

9. Appliance does not drain;

- Check and clean the filters.
- Check if drain hose and drain vent are not clogged.
- In appliances with a motorized drain unit, drain system should comply with section 4.6.

10. Water intake is slow;

- Check if water supply taps are open.
- Check water pressure. It should be 2-4 bars. If pressure is low, fit a booster pump.
- Clean water outlet parts on the rinsing arms.
- Check if water hose is clogged or bent.
- If low pressure is due to the pressure reducer on the water supply line, regulator can be removed.



Attention: If any wrong installation or use is found during the service under product warranty, a service fee is charged.



CAUTION



The building, facility or area where the appliance is to be installed should have a proper electrical installation as per the interior wiring regulation, and all measures for life and property safety should be taken.

OTHERWISE, OUR COMPANY WILL NOT ACCEPT ANY LIABILITY.

NOTE:.....

.....

.....

.....

.....

.....

.....

.....

.....

.....

.....

.....

.....

.....

.....

.....

.....

.....

.....

.....

.....

NOTE:.....

.....

.....

.....

.....

.....

.....

.....

.....

.....

.....

.....

.....

.....

.....

.....

.....

.....

.....

.....

.....

